



DICTUM

KNIVES

2021 / 2022

MORE THAN TOOLS

CONTACT

Telephone

Ordering
+49 (0)9931 4058-902

Consulting
+49 (0)9931 4058-912

Sharpening advice
+49 (0)9931 4058-971

Our lines are open:
Monday till Friday from
8.00 am to 7.00 pm.

Post

DICTUM GmbH
Gottlieb-Daimler-Str. 3
94447 Plattling - Germany

Retail shops

DICTUM Shop - Plattling
Gottlieb-Daimler-Str. 3
94447 Plattling - Germany

DICTUM Shop - Munich
Haager Str. 9
2nd Floor
81671 Munich - Germany

► *For further information
see page 227.*

Online

Online shop
www.dictum.com

Sharpening tips
www.perfect-sharpening.com

 **DictumGmbH**

 **DICTUM.MehrAlsWerkzeug**

 **dictum_mehr_als_werkzeug**

Order conveniently online
or browse through our interactive
flip catalogues.

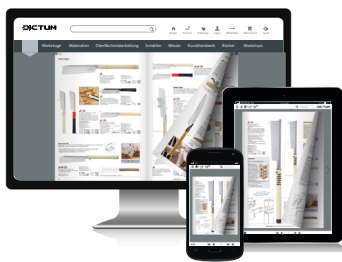

OUR PHILOSOPHY
FOLLOWS A SIMPLE PRINCIPLE:
SHARPNESS, EDGE RETENTION,
PERFECTION.





CONTENT

Knives, Masterpieces of Forging 04

■ **KITCHEN KNIVES**

Kitchen Knives / Japanese Knives 10
Knives for Special Applications 102

INTERESTING FACTS

Original Japanese Knives 07
 Knife Shapes 08
 Japanese Knife Construction 40
 Knife Handles 41
 Surfaces and Steel Terms 59
 Steel Types 60
 Tips on Handling and Care of Kitchen Knives 100

■ **HUNTING AND OUTDOOR KNIVES**

Fixed Blade Knives 113
Folding Knives 145

INTERESTING FACTS

Steel Types 114
 Locking Mechanisms 146

■ **SHARPENING**

Sharpening of Knife Blades 207
Sharpening with Bench Stones 208
Sharpening on Water-cooled Sharpening Machines 213
Sharpening with Knife Sharpening Systems 214
Polishing Knife Blades 221
Workshops 222
Books 224

Service 225
 Our Obligation to Inform 226

KNIVES

MASTERPIECES OF FORGING

DICTUM employs its own steel and knife experts and has been closely working with leading Japanese cutting tool manufacturers for decades. All Hocho knives offered by DICTUM are exclusively made in Japan and are distinguished by their sharpness, durability and best workmanship. **With us you get the originals!**

FOR US, VALUES ARE MORE THAN JUST WORDS

Our extensive service shows how it is important to us to put our company philosophy into practice. We are committed to your needs and we live our values for your benefit. Each and every day.



Includes premium sharpening service

You can have premium class products that bear this logo sharpened by our experts at any time free of charge and without limitation. And you pay only the shipping costs.



Includes sharpening pass

Products marked with this symbol come with a sharpening pass, which entitles you to two free sharpenings. Just send us your cutting tool with its sharpening pass and we will sharpen it free of charge and return it within a few days. All you pay is the shipping costs.

General sharpening service

For more information on our general sharpening service and other services we offer, see page 225.

Buy at no risk

All our products come with a 30-day right of return.

DICTUM Shops

All products can be tested in our shops. Our consultants are specifically trained professionals, who will help you to select the cutting tool you are looking for. Further they will give you useful tips and tricks for care and sharpening after purchase.

Vide

A product or application video is available on our website www.dictum.com/videos for products with this symbol.

TRADITION AND CRAFTS

For centuries, outstanding knives with traditional blades shapes have been manufactured in the traditional manner in small Japanese workshops, where precision and experience have a decisive role to play. Forging is a transformation process that not only determines the outer shape, but also alters the internal structure of the steel. Proper forging improves the ductility and sharpening capability of the blade. That is how the blacksmith creates step by step unique pieces.





JAPANESE KNIVES

QUALITY IN THE KITCHEN STARTS WITH CUTTING!

Original Japanese knives

Japan has cultivated the aesthetics of food preparation like no other country, with the Hocho - the handforged knife - being the most important tool. Outstanding knives with traditional blade shapes have been made in the traditional manner in small Japanese workshops for centuries. Often with a high level of manual work or even completely handmade.

They are valued by experts because of their ergonomics and extreme sharpness and edge retention for perfect and precise work. The razor-sharp cut does not crush the cells, the juice is retained, and the natural flavour of the food comes into its own.

How do I identify a Japanese knife?

The visible quality features of original Japanese knives include:

- The traditional form
- They often have a Japanese signature (not a Chinese one!)
- As Japanese blades are always made of at least two and usually even three layers of metal, a wavy border line must be visible at the cutting edge
- The so-called Suminagashi pattern - the Damascus-like structure on multi-layered steel - is often imitated in cheap knives by etching; when buying a knife, compare two knives of the same type; the etched pattern is always the same, while the structure lines on multi-layered steel are slightly different in each knife
- Hardness 58-66 HRC

Beware of fakes!

Widely used Japanese-looking knives from Asian low-wage countries are often only similar in shape to the original Hocho. With us you get the originals! All Hocho offered by DICTUM are exclusively made in Japan and are distinguished by their sharpness, cutting properties and best materials.

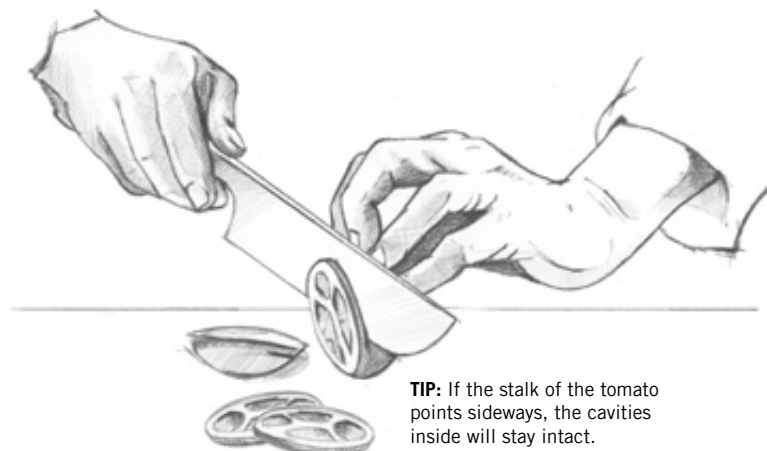

TIP: If the stalk of the tomato points sideways, the cavities inside will stay intact.

CHOOSING THE RIGHT KNIFE SHAPE

There are many different shapes of Japanese knives - each of them has certain characteristics and is designed for the preparation of certain raw materials. The intended use is crucial for choosing the right knife. If you would like to get yourself a basic set of Japanese knives, we recommend the following shape knives: A Santoku (all-purpose knife) plus a Petty (fruit and peeling knife) or a Gyuto (fish and meat knife) with a blade length of up to 150 mm.



Santoku

All-purpose knife for meat, fish and vegetable (Santoku = the three virtues). Wide blade for good guidance along the finger knuckles.



Bunka

Original shape of the all-purpose knife for meat, fish and vegetables. Also suitable for chopping herbs. Later, the all-purpose knife »Santoku« developed from the Usuba and Gyuto shape.



Usuba

Vegetable knife with straight blade for clean cutting on the chopping board; paper-thin slices are no problem, even with ripe tomatoes.



Petty

Small all-purpose knife for fruit, peeling and cutting small objects.



Gyuto/Kiritsuke

Versatile cooking knife for cutting up, filleting and preparing meat and fish. Slim blades for intricate tasks, pull or push cuts.



Ajikiri

For small fish and for cleaning vegetables and salads, as well as chopping herbs.



Sashimi/Yanagiba

For cutting and filleting fish or ham with a pull stroke. Slim blade in the shape of a willow leaf or Katana (sword). Usually with single bevel for precise filleting and wafer-thin cuts.



Sujihiki

Versatile cooking knife. The long, slender blade shape is suitable for slicing, filleting and preparing meat and fish. With double bevel.



Takobiki

Fish knife with slightly curved blade tip in the form of a Japanese Katana (sword). It is suitable for processing fish fillet to sashimi and sushi and for portioning octopus.



Deba

For cutting fish and light mincing. Thick, wide blade. The back of the blade can be used to chop thin bones.

© For a video explaining the different knife shapes and their uses see www.dictum.com

THE USUBA

The Usuba is part of a Japanese cook's basic toolkit. In Europe, the vegetable knife does not yet enjoy such attention, but it is becoming increasingly popular and deservedly so. The high blade back makes the blade easy to guide, which is ideal when chopping large quantities of vegetables in a short amount of time. With a straight cutting edge for clean cuts on a chopping board, even ripe tomatoes can be cut into wafer-thin slices.





HOCHO DELUXE

The forging of knives has always had a strongly mystical cultural history. This is the only explanation why the products are often enhanced way beyond their actual utility. The passionate search for perfection, characterised by the Samurai sword blacksmiths, can still be found in certain blacksmiths today. One of them is Yoshikazu Tanaka, where these perfectly formed Hocho are created. He joins multiply folded, high-purity carbon steel with a cutting edge of Blue Paper Steel to make exceptional blades with a hardness of 61 HRC. The result persuades with a classical wave pattern on the wide side of the blade and a breathtaking sharp cutting edge. The octagonal shaped handle made of Macassar ebony, a very dense, non-fading and ageing-resistant precious wood, is completed with a buffalo horn ferrule. The blade comprises 15 layers in total with a right-hand bevel, not rustproof.

 **A HOCHO DELUXE**

1 Deba
 Blade length 185 mm
 Blade thickness 7 mm
 Overall length 340 mm
 370 g
No. 719713

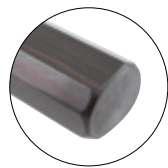

Octagonal handle made of Macassar ebony.

2 Usuba, Vegetable Knife
 Blade length 170 mm
 Blade thickness 3.7 mm
 Overall length 325 mm
 225 g
No. 719714

3 Sashimi, Fish Knife
 Blade length 290 mm
 Blade thickness 3.2 mm
 Overall length 450 mm
 235 g
No. 719715

**Inclusive free sharpening pass.
 For more information see page 4.**

 Lifetime sharpening



熊五郎



A



1

2

3



SHIGEFUSA

Original and authentic

Master Shigefusa uses original materials to create knives in classical shapes following the strict code of traditional Japanese aesthetics. With meditative devotion, he creates the finest blades in his workshop using traditional swordsmithing methods. This includes forge-welding of the individual layers in a charcoal furnace, forming of the blades with a scraper blade and then grinding and polishing by hand on a veritable arsenal of water-stones. Magnolia wood handles with buffalo horn ferrules. Cutting edge made of non-rustproof carbon steel (V1), hardness 64 HRC.

重房



A SHIGEFUSA HOCHO KITAEJI
61 layers, double-bevelled.

1 *Santoku, All-purpose Knife*
Blade length 165 mm
Blade thickness 2.2 mm
Overall length 310 mm
150 g
No. 719137

2 *Usuba, Vegetable Knife*
Blade length 160 mm
Blade thickness 2 mm
Overall length 310 mm
185 g
No. 719666

B SHIGEFUSA HOCHO KASUMI
Triple-layered blade, double-bevelled.
Surface has a forged structure, gunmetal finish.

1 *Santoku, All-purpose Knife*
Blade length 165 mm
Blade thickness 2.2 mm
Overall length 310 mm
155 g
No. 719665

Edged handle made of magnolia wood, for right-handed use.

2 *Usuba, Vegetable Knife*
Blade length 160 mm
Blade thickness 2 mm
Overall length 310 mm
180 g
No. 719206

Inclusive free sharpening pass.
For more information see page 4.



Two free sharpenings



Lifetime sharpening



取
五
作

YAMAMOTO

Hand-forged Japanese kitchen knives made by master knifemaker Masashi Yamamoto. The blade's high-contrast Suminagashi pattern is created by a total of 57 folded layers of steel. The core cutting layer of Hitachi SLD steel* guarantees excellent sharpness and edge life due to its high carbon content; rustproof side layers facilitate care. The perfect look of the Japanese knife is completed by its handle made of enju wood (wood of the Japanese pagoda tree), which is finished off with a buffalo horn ferrule. Blade with hand-engraved signature. Double bevel, hardness 63 HRC. Rust-resistant cutting core layer, rustproof side layers.

* Steel analysis: C = 1.5 / Si = 0.25 / Mn = 0.4 /
Cr = 12 / Mo = 1 / V = 0.35 (in %)



 **A YAMAMOTO HOCHO**

1 Santoku, All-purpose Knife
 Blade length 165 mm
 Blade thickness 1.7 mm
 Overall length 305 mm
 145 g
No. 720053

2 Usuba, Vegetable Knife
 Blade length 165 mm
 Blade thickness 1.7 mm
 Overall length 315 mm
 170 g
No. 720054

3 Petty, Small All-purpose Knife
 Blade length 125 mm
 Blade thickness 1.5 mm
 Overall length 260 mm
 65 g
No. 720052

4 Gyuto, Fish and Meat Knife
 Blade length 150 mm
 Blade thickness 1.5 mm
 Overall length 280 mm
 100 g
No. 720055

5 Gyuto, Fish and Meat Knife
 Blade length 180 mm
 Blade thickness 1.7 mm
 Overall length 320 mm
 150 g
No. 720056

6 Gyuto, Fish and Meat Knife
 Blade length 210 mm
 Blade thickness 1.8 mm
 Overall length 355 mm
 210 g
No. 720057

7 Gyuto, Fish and Meat Knife
 Blade length 240 mm
 Blade thickness 1.8 mm
 Overall length 405 mm
 235 g
No. 720058

8 Sujihiki, Fish and Meat Knife
 Blade length 240 mm
 Blade thickness 1.5 mm
 Overall length 390 mm
 130 g
No. 720059



Edged handle
 made of enju wood.

Inclusive free sharpening pass.
For more information see page 4.

 Two free sharpenings

9 

9 2-Piece Set *Price advantage*
 • Santoku, all-purpose knife (No. 720053)
 • Petty, small all-purpose knife (No. 720052)
No. 720060

A



Kiritsuke, a variant of the Gyuto knife

A YAMAMOTO HOCHO SLD
 Traditional Japanese knives with forged skin and traditional character. The perfect antique look of the Japanese knife is completed by the handle made of flamed chestnut wood which is finished with a buffalo horn ferrule. The wooden surface is brushed after the burning process, which creates a slightly structured appearance and gives the handle a rustic charm. The core cutting layer made of Hitachi SLD steel* guarantees excellent sharpness and edge life due to its high carbon content; rustproof side layers facilitate maintenance. Double bevel, hardness 62 HRC. Rust-resistant core cutting layer, rustproof outer layers. Available from August 2021.

*Steel analysis: C = 1.5 / Si = 0.25 / Mn = 0.4 / Cr = 12 / Mo = 1 / V = 0.35 (in %)

1 Santoku, All-purpose Knife
 Blade length 165 mm
 Blade thickness 2 mm
 Overall length 300 mm
 155 g
No. 718670

2 Usuba, Vegetable Knife
 Blade length 175 mm
 Blade thickness 2.1 mm
 Overall length 310 mm
 190 g
No. 718671

3 Petty, Small All-purpose Knife
 Blade length 120 mm
 Blade thickness 1.7 mm
 Overall length 255 mm
 65 g
No. 718672

4 Gyuto, Fish and Meat Knife
 Blade length 150 mm
 Blade thickness 1.7 mm
 Overall length 275 mm
 95 g
No. 718673

5 Gyuto, Fish and Meat Knife
 Blade length 180 mm
 Blade thickness 2 mm
 Overall length 320 mm
 150 g
No. 718674

6 Gyuto, Fish and Meat Knife
 Blade length 210 mm
 Blade thickness 1.8 mm
 Overall length 350 mm
 185 g
No. 718675

7 Gyuto, Fish and Meat Knife
 Blade length 240 mm
 Blade thickness 2 mm
 Overall length 390 mm
 235 g
No. 718676

8 Sujihiki, Fish and Meat Knife
 Blade length 240 mm
 Blade thickness 1.9 mm
 Overall length 390 mm
 230 g
No. 718677



Octagonal handle made of chestnut wood.

Inclusive free sharpening pass.
For more information see page 4.
 Two free sharpenings



10 2-Piece Set Price advantage
 • Santoku, all-purpose knife (No. 718670)
 • Petty, small all-purpose knife (No. 718672)
No. 718678

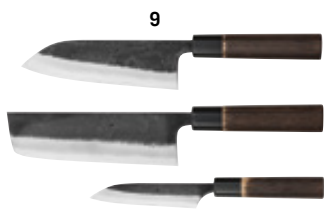

9 3-Piece Set Price advantage
 • Santoku, all-purpose knife (No. 718670)
 • Usuba, vegetable knife (No. 718671)
 • Petty, small all-purpose knife (No. 718672)
No. 718679



聖作



OKADA

A OKADA HOCHO
 Masanobu Okada is a Japanese »Dento-Kogeishi« - a master of traditional crafts. Working out of the Takefu Knife Village, he represents the third generation of his family to fashion superb kitchen knives. The blade's individual Suminagashi pattern is produced by 20 layers of folded steel enclosing the core cutting layer made of White Paper Steel. This ultrapure carbon steel has extraordinarily fine grinding properties, allowing it to achieve outstanding sharpness. The sandalwood handle possesses a fascinating brown hue with dark lines, and is completed with a black ferrule made of wood laminate. Right-handers will find the knife extremely comfortable to hold thanks to the finger groove positioned on the right side of the handle. The blade bears the signature of the smith and is double-bevelled. Hardness 60 HRC, not rustproof.

1 Yanagiba, Fish Knife
 Suitable for portioning and filleting fish, and for preparing sushi.
 Blade length 260 mm
 Blade thickness 3.4 mm
 Overall length 405 mm
 200 g
No. 719879

Takobiki
 Fish knife with a tapered blade tip in the form of a Japanese Katana (sword). The Takobiki is ideal for cutting fish fillets when making sashimi and sushi, but also to portion octopus. However, you will also enjoy this knife for all other cuttings tasks.

2 270 mm
 Blade length 270 mm
 Blade thickness 3.3 mm
 Overall length 410 mm
 170 g
No. 719880

3 300 mm
 Blade length 300 mm
 Blade thickness 3.3 mm
 Overall length 440 mm
 200 g
No. 719884

Inclusive free sharpening pass. For more information see page 4.

 Two free sharpenings



Edged handle made of sandalwood, for right-handed use.





誠
貴
匠

SHIGEKI »CLASSIC«

Every piece is unique: Master Shigeki practices steel folding and forge-welding with great virtuosity to create blades with an enchanting aesthetic - each one unique in its structure. Hard Blue Paper Steel is used for the core cutting layer and low alloyed steels for the outer layers. Every knife is hand signed and packed in a beautiful case made of kiri wood. Magnolia wood handle with a buffalo horn ferrule and finger groove for right hand use. Hardness 64 HRC, not rustproof.



Edged handle made of magnolia wood, for right-handed use.

 **A SHIGEKI HOCHO »CLASSIC«**

1 Santoku, All-purpose Knife
31 layers, double-bevelled.
Blade length 165 mm
Blade thickness 2.8 mm
Overall length 310 mm
130 g
No. 719290

2 Gyuto, Fish and Meat Knife
31 layers, double-bevelled.
Blade length 105 mm
Blade thickness 2.1 mm
Overall length 240 mm
55 g
No. 719790

3 Gyuto, Fish and Meat Knife
31 layers, double-bevelled.
Blade length 135 mm
Blade thickness 1.8 mm
Overall length 270 mm
60 g
No. 719791

4 Gyuto, Fish and Meat Knife
31 layers, double-bevelled.
Blade length 150 mm
Blade thickness 2 mm
Overall length 275 mm
75 g
No. 719792

5 Gyuto, Fish and Meat Knife
31 layers, double-bevelled.
Blade length 185 mm
Blade thickness 2.5 mm
Overall length 320 mm
125 g
No. 719386

6 Gyuto, Fish and Meat Knife
31 layers, double-bevelled.
Blade length 210 mm
Blade thickness 2.4 mm
Overall length 355 mm
150 g
No. 719793

7 Sashimi, Fish Knife
17 layers, single-bevelled
(right-handed use).
Blade length 230 mm
Blade thickness 4 mm
Overall length 375 mm
160 g
No. 719183

8 Deba
17 layers, single-bevelled
(right-handed use).
Blade length 170 mm
Blade thickness 6.5 mm
Overall length 310 mm
280 g
No. 719184

9 Usuba, Vegetable Knife
31 layers, double-bevelled.
Blade length 165 mm
Blade thickness 1.7 mm
Overall length 310 mm
130 g
No. 719794



Inclusive free sharpening pass.
For more information see page 4.



Two free sharpenings



10 2-Piece Set *Price advantage*
• Gyuto, fish and meat knife (No. 719791)
• Santoku, all-purpose knife (No. 719290)
No. 719798

石置
誠
貴
作



SHIGEKI »EBONY«

Every piece is unique: Master Shigeki practices steel folding and forge-welding with great virtuosity to create blades with an enchanting aesthetic - each one unique in its structure. Hard Blue Paper Steel is used for the core cutting layer and low alloyed steels for the outer layers. Every knife is hand signed and packed in a beautiful case made of kiri wood. Magnolia wood handle with a buffalo horn ferrule and finger groove for right hand use. Hardness 64 HRC, not rustproof.



A SHIGEKI HOCHO »EBONY«

1 *Santoku, All-purpose Knife*

Blade length 165 mm
Blade thickness 1.8 mm
Overall length 300 mm
140 g

No. 718660

2 *Usuba, Vegetable Knife*

Blade length 165 mm
Blade thickness 2.1 mm
Overall length 305 mm
180 g

No. 718661

3 *Gyuto, Fish and Meat Knife*

Blade length 135 mm
Blade thickness 1.6 mm
Overall length 265 mm
85 g

No. 718662

4 *Gyuto, Fish and Meat Knife*

Blade length 150 mm
Blade thickness 1.7 mm
Overall length 180 mm
95 g

No. 718663

5 *Gyuto, Fish and Meat Knife*

Blade length 180 mm
Blade thickness 2 mm
Overall length 320 mm
145 g

No. 718664

6 *Gyuto, Fish and Meat Knife*

Blade length 210 mm
Blade thickness 2.1 mm
Overall length 355 mm
180 g

No. 718665

7 *Gyuto, Fish and Meat Knife*

Blade length 235 mm
Blade thickness 2 mm
Overall length 395 mm
205 g

No. 718666

8 *Gyuto, Fish and Meat Knife*

Blade length 270 mm
Blade thickness 2.1 mm
Overall length 420 mm
245 g

No. 718667

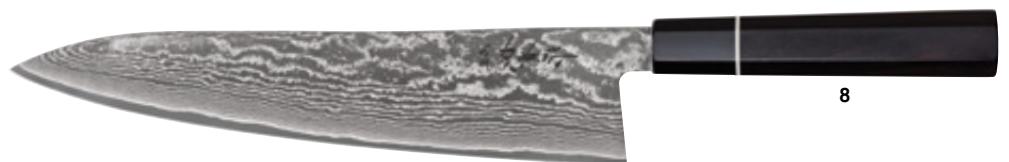
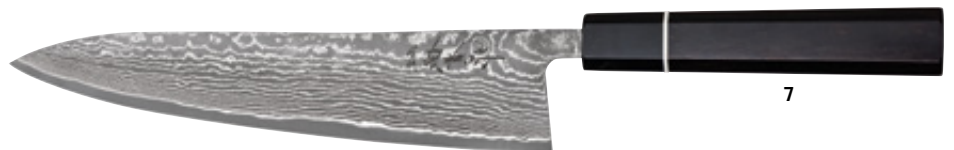
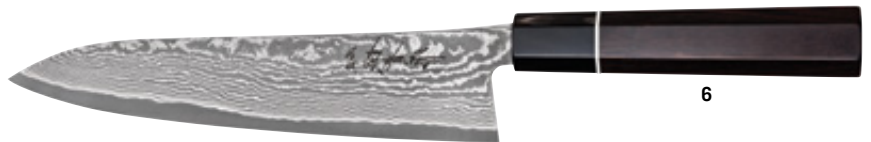
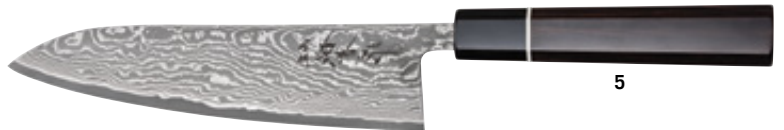

Octagonal handle made of ebony.



9

9 *2-Piece Set* **Price advantage**

- Santoku, all-purpose knife (No. 718660)
- Gyuto, fish and meat knife (No. 718662)

No. 718668

Inclusive free sharpening pass.
For more information see page 4.

Lifetime sharpening

ANRYU

Takefu Knife Village

The Takefu Knife Village is a cooperative of blade-smithing specialists. It has upheld the tradition of metalworking for almost 700 years. A small group of extremely skilled master smiths forge limited series of superb knives in their smithies located in the tiny village in Fukui Province. They craft their products by hand to create one-of-a-kind Japanese kitchen knives made only of the best materials.



A ANRYU HOCHO
Master smith Katsushige Anryu is the progeny of a knife-making family fashioning high-quality kitchen knives in the fourth generation. The smith was awarded the title of »Dento-Kogeishi« - »Master of Traditional Crafts« - in honour of his work. The blade consists of 33 layers in total that create a distinct and delightfully appealing structure. The cutting layer is made of rustproof VG-10 steel, and the outer layers are also rust-proof to ensure easy care. The octagonal, brown sandalwood handle is completed with a ferrule of black wood laminate. The double-bevelled blade bears the smith's signature. Hardness 60 HRC.

1 Santoku, All-purpose Knife
Blade length 170 mm
Blade thickness 1.9 mm
Overall length 310 mm
130 g
No. 719920

2 Bunka, All-purpose Knife
Blade length 165 mm
Blade thickness 2 mm
Overall length 310 mm
135 g
No. 719921

3 Bunka, All-purpose Knife
Blade length 125 mm
Blade thickness 1.9 mm
Overall length 255 mm
85 g
No. 719922

4 Usuba, Vegetable Knife
Blade length 165 mm
Blade thickness 2.2 mm
Overall length 305 mm
185 g
No. 719923

5 Gyuto, Fish and Meat Knife
Blade length 130 mm
Blade thickness 2 mm
Overall length 255 mm
75 g
No. 719924

6 Gyuto, Fish and Meat Knife
Blade length 180 mm
Blade thickness 2 mm
Overall length 325 mm
140 g
No. 719925

7 Boning Knife
Blade length 150 mm
Blade thickness 1.9 mm
Overall length 290 mm
110 g
No. 719926

越前
勝重
作



8



- 8 2-Piece Set** *Price advantage*
- Santoku, all-purpose knife (No. 719920)
 - Gyuto, fish and meat knife (No. 719924)
- No. 719927**



Octagonal handle made of brown sandalwood.

Inclusive free sharpening pass.
For more information see page 4.



Two free sharpenings





薙
かじ屋
文
責

OCHI

The archetype of the Japanese knife

Each of these triple-layered blades, made according to a traditional design, is personally signed by the master blacksmith. The cutting edge of hard Blue Paper Steel (61 HRC) is flanked by tough steel. The black-burned surface forms an effective contrast to the ferrule of extremely rare, grained buffalo horn and the handle of natural magnolia wood. Not rustproof, double-bevelled.



A OCHI HOCHO

1 *Santoku, All-purpose Knife*

Blade length 165 mm
Blade thickness 3.5 mm
Overall length 310 mm
160 g
No. 719251

2 *Usuba, Vegetable Knife*

Blade length 150 mm
Blade thickness 3.5 mm
Overall length 300 mm
140 g
No. 719252

3 *Ajikiri, Trimming Knife*

Blade length 120 mm
Blade thickness 3 mm
Overall length 235 mm
60 g
No. 719250

4 *Herbs Knife*

Blade length 90 mm
Blade thickness 2.7 mm
Overall length 205 mm
70 g
No. 719249



5 *Ochi Hocho, 2-Piece Set* *Price advantage*

- Santoku, all-purpose knife (No. 719251)
- Usuba, vegetable knife (No. 719252)

No. 719339

5



Inclusive free sharpening pass.
For more information see page 4.



Two free sharpenings

Edged handle
made of magnolia
wood, for right-
handed use.



新
金太郎
作



KANEHIRO

Takefu Knife Village

The Takefu Knife Village is a cooperative of blade-smithing specialists. It has upheld the tradition of metalworking for almost 700 years. A small group of extremely skilled master smiths forge limited series of superb knives in their smithies located in the tiny village in Fukui Province. They craft their products by hand to create one-of-a-kind Japanese kitchen knives made only of the best materials.



A KANEHIRO HOCHO

Japanese kitchen knife by master smith Hiroshi Kato, who has hand-crafted beautiful cutting tools for over 50 years. Delicate traces of hammering decorate the upper section of the triple-layered blade, giving the knife its rustic charm. The cutting layer is made of tough and hard Blue Paper Steel; this highly pure

carbon steel guarantees exceptional sharpness and durability. Rustproof steel is used for the outer layers to facilitate maintenance. The octagonal handle made of American cherry wood is completed with a black wood laminate ferrule. The blade is hand-signed using an engraving stylus. Double bevel, hardness 62 HRC.

Inclusive free sharpening pass.
For more information see page 4.



Two free sharpenings

1 Santoku, All-purpose Knife
 Blade length 165 mm
 Blade thickness 1.6 mm
 Overall length 310 mm
 130 g
No. 719930



2 Usuba, Vegetable Knife
 Blade length 165 mm
 Blade thickness 1.8 mm
 Overall length 305 mm
 150 g
No. 719931



3 Gyuto, Fish and Meat Knife
 Blade length 145 mm
 Blade thickness 2 mm
 Overall length 275 mm
 80 g
No. 719932



4 Gyuto, Fish and Meat Knife
 Blade length 180 mm
 Blade thickness 1.9 mm
 Overall length 320 mm
 130 g
No. 719933



5 Gyuto, Fish and Meat Knife
 Blade length 210 mm
 Blade thickness 2 mm
 Overall length 350 mm
 160 g
No. 719934



6 Gyuto, Fish and Meat Knife
 Blade length 240 mm
 Blade thickness 1.6 mm
 Overall length 390 mm
 170 g
No. 719935



7 Sujihiki, Fish and Meat Knife
 Blade length 265 mm
 Blade thickness 1.6 mm
 Overall length 420 mm
 160 g
No. 719936



Octagonal handle made of American cherry wood.

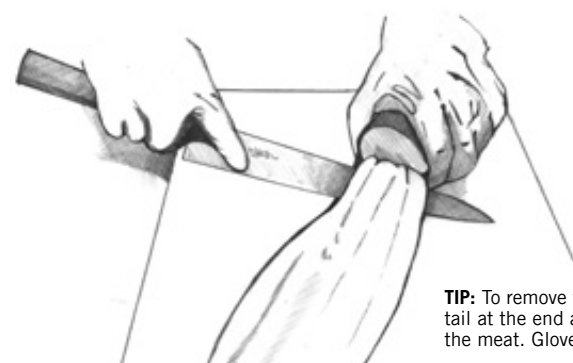

TIP: To remove the skin from a fish side, cut the tail at the end and fillet with the blade flat along the meat. Gloves protect your hands from injury.

8 2-Piece Set Price advantage
 • Santoku, all-purpose knife (No. 719930)
 • Gyuto, fish and meat knife (No. 719932)
No. 719937





新
金太郎
作

YOSHIMI KATO

Traditional Japanese kitchen knives by Yoshimi Kato

The son-in-law of famous master blacksmith Hiroshi Kato continues the traditional Kanehiro Hamono forge.



Inclusive free sharpening pass.
For more information see page 4.



Two free sharpenings

A **YOSHIMI KATO HOCHO**
The attractive Damascus structure consists of 16 outer layers of rustproof steel and a core layer of likewise rustproof VG-10 steel. The elegant octagonal handle made of keyaki wood (Japanese zelkova) has a pakka wood ferrule. Knife with double bevel, rustproof, hardness 60 HRC.

1 Santoku, All-purpose Knife
Blade length 170 mm
Blade thickness 2 mm
Overall length 310 mm
130 g
No. 718480

2 Bunka, All-purpose Knife
Blade length 160 mm
Blade thickness 1.8 mm
Overall length 315 mm
130 g
No. 718481

3 Usuba, Vegetable Knife
Blade length 160 mm
Blade thickness 2 mm
Overall length 305 mm
150 g
No. 718482

4 Gyuto, Fish and Meat Knife
Blade length 120 mm
Blade thickness 1.7 mm
Overall length 250 mm
65 g
No. 718483

5 Gyuto, Fish and Meat Knife
Blade length 145 mm
Blade thickness 2.3 mm
Overall length 275 mm
70 g
No. 718484

6 Gyuto, Fish and Meat Knife
Blade length 215 mm
Blade thickness 2.1 mm
Overall length 360 mm
150 g
No. 718485

7 Gyuto, Fish and Meat Knife
Blade length 240 mm
Blade thickness 2 mm
Overall length 390 mm
170 g
No. 718486

8 Sujihiki, Fish and Meat Knife
Blade length 265 mm
Blade thickness 2 mm
Overall length 420 mm
175 g
No. 718487



Elegant octagonal handle made of Keyaki wood (Japanese zelkova).





YOSHIMI KATO SG-2

These Japanese kitchen knives by Yoshimi Kato are real head-turners for your kitchen. The son-in-law of the famous master blacksmith Hiroshi Kato continues the traditional Kanehiro Hamono forge. Distinctly rich in contrast, this eye-catching blade consists of 63 layers in total. The cutting edge made of SG-2 steel manufactured using powder metallurgy lends it an exceptional sharpness and durability. The elegant octagonal walnut handle is finished with a red pakka wood ferrule. Double bevel, rustproof, hardness 63 HRC.

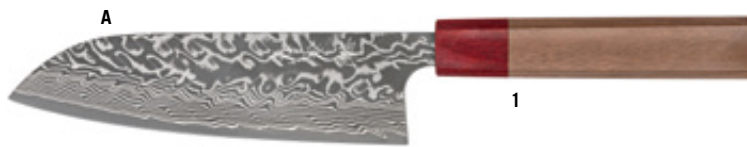

1



2

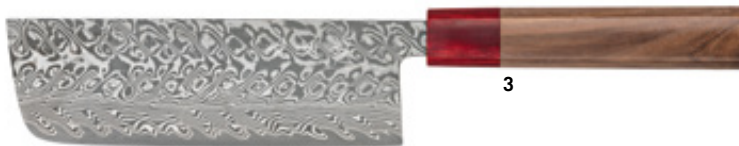

3



4



5



6



7



8

Octagonal handle made of walnut wood.



A YOSHIMI KATO HOCHO SG-2

1 Santoku, All-purpose Knife
Blade length 170 mm
Blade thickness 1.9 mm
Overall length 305 mm
120 g
No. 708480

2 Bunka, All-purpose Knife
Blade length 165 mm
Blade thickness 1.7 mm
Overall length 300 mm
110 g
No. 708481

3 Usuba, Vegetable Knife
Blade length 165 mm
Blade thickness 1.7 mm
Overall length 300 mm
140 g
No. 708482

4 Petty, Small All-purpose Knife
Blade length 120 mm
Blade thickness 1.4 mm
Overall length 245 mm
50 g
No. 708483

5 Gyuto, Fish and Meat Knife
Blade length 150 mm
Blade thickness 1.5 mm
Overall length 270 mm
55 g
No. 708484

6 Gyuto, Fish and Meat Knife
Blade length 210 mm
Blade thickness 1.6 mm
Overall length 350 mm
120 g
No. 708485

7 Gyuto, Fish and Meat Knife
Blade length 240 mm
Blade thickness 1.5 mm
Overall length 390 mm
120 g
No. 708486

8 Sujihiki, Fish and Meat Knife
Blade length 270 mm
Blade thickness 1.8 mm
Overall length 410 mm
120 g
No. 708487

Inclusive free sharpening pass.
For more information see page 4.



Two free sharpenings



9

9 2-Piece Set Price advantage
• Santoku, all-purpose knife (No. 708480)
• Petty, small all-purpose knife (No. 708483)
No. 708488

HIDEO KITAOKA

These traditional Japanese knives are handmade by Hideo Kitaoka. The master blacksmith learned his craft from his father at a young age and is now known for his traditional Japanese knives. He uses White Paper Steel for the core cutting layer. This high-purity carbon steel can be ground very finely and thus achieves excellent sharpness. The edged oval handle made of flamed chestnut wood is finished with a buffalo horn ferrule. The wooden surface is brushed after the burning process, which creates a slightly structured appearance and gives the handle a rustic charm. Blade with surface structure; the Funayuki and Yanagiba models feature the traditional Machi notch between blade and tang. This traditional design has its origin in the shape of Japanese swords. The knives are equipped with a hand guard at this point. Single bevel for right-handed use, not rustproof, double-layered, hardness 63 HRC.

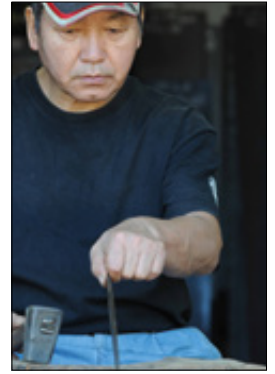

熱前武生

For
FISH
LOVERS

This knife series is
ideal for cutting and
filleting fish.



B HIDEO KITAOKA HOCHO

1 Funayuki, All-purpose Knife
In former times, the Funayuki was used as an all-purpose knife on fishing boats. It is somewhat stronger than a Santoku and is also suitable for filleting fish.
Blade length 180 mm
Blade thickness 3.9 mm
Overall length 300 mm
180 g
No. 708875

2 Kasaiki, Small All-purpose Knife
For cutting and filleting small fish, as well as for preparing vegetables or other small cutting jobs.
Blade length 120 mm
Blade thickness 2.40 mm
Overall length 240 mm
70 g
No. 708876



The octagonal handle made of flamed chestnut wood is edged on the right side.

3 Ajikiri, Trimming Knife
The wide blade of the Ajikiri is ideal for preparing small fish, vegetables and salad, as well as chopping and cutting herbs.
Blade length 120 mm
Blade thickness 2.8 mm
Overall length 240 mm
90 g
No. 708877

4 Yanagiba, Fish Knife
Suitable for portioning and filleting fish, and for preparing sushi.
Blade length 240 mm
Blade thickness 3.7 mm
Overall length 365 mm
165 g
No. 708878

5 Yanagiba, Fish Knife
Suitable for portioning and filleting fish, and for preparing sushi.
Blade length 270 mm
Blade thickness 3.7 mm
Overall length 415 mm
195 g
No. 708879

TADAFUSA NASHIJI

The forged skin with hammered structure gives the blade an original and rustic appearance. A thermally treated* chestnut wood handle with black plastic ferrule fits the blade. The cutting edge of Blue Paper Steel is perfectly polished and sharpened, the outer layers are of rust-proof steel which makes it easier to care for. Not rustproof, double bevel cutting edge, hardness 63 HRC.



A TADAFUSA HOCHO NASHIJI

1 Santoku, All-purpose Knife
Blade length 165 mm
Blade thickness 2 mm
Overall length 305 mm
135 g
No. 719940

2 Usuba, Vegetable Knife
Blade length 150 mm
Blade thickness 2.2 mm
Overall length 295 mm
150 g
No. 719941

3 Ajikiri, Trimming Knife
Blade length 105 mm
Blade thickness 3 mm
Overall length 225 mm
75 g
No. 719942

4 Gyuto, Fish and Meat Knife
Blade length 135 mm
Blade thickness 2.7 mm
Overall length 250 mm
75 g
No. 719943

5 Gyuto, Fish and Meat Knife
Blade length 210 mm
Blade thickness 2.2 mm
Overall length 360 mm
170 g
No. 719944

6 Sujihiki, Fish and Meat Knife
Blade length 165 mm
Blade thickness 3 mm
Overall length 310 mm
125 g
No. 719945

7 Sujihiki, Fish and Meat Knife
Blade length 240 mm
Blade thickness 2 mm
Overall length 390 mm
150 g
No. 719946

* *Thermic wood: Under the effect of heat (170-250 °C) and steam, the wood structure is changed and improved for special uses (e.g. in the kitchen) in a targeted and natural way without adding any chemicals. During the special treatment process, the cell wall structure is modified in such a way that the ability to absorb water is reduced and the resistance against bacteria is increased. The thermal treatment also lends the wood a slightly darker tone.*

忠虎作

8



- 8 2-Piece Set, Santoku and Usuba *Price advantage*
- Santoku, all-purpose knife (No. 719940)
 - Usuba, vegetable knife (No. 719941)
- No. 719947

9



- 9 2-Piece Set, Santoku and Gyuto *Price advantage*
- Santoku, all-purpose knife (No. 719940)
 - Gyuto, fish and meat knife (No. 719943)
- No. 719948



Oval handle made of chestnut wood.

Inclusive free sharpening pass.
For more information see page 4.



Two free sharpenings



TADAFUSA

Light Japanese kitchen knives from the traditional Tadafusa smithy. The high-contrast blade consists of a total of 35 layers of Suminagashi steel. High-purity White Paper Steel is used for the cutting layer, which can be ground extremely finely. The oval handle made of thermally treated* chestnut wood is completed with a black synthetic ferrule. Double bevel, not rustproof. Hardness 63 HRC.

角利

日本製



 **A TADAFUSA HOCHO**

1 Santoku, All-purpose Knife
 Blade length 165 mm
 Blade thickness 1.5 mm
 Overall length 305 mm
 120 g
No. 719980

3 Gyuto, Fish and Meat Knife
 Blade length 135 mm
 Blade thickness 1.4 mm
 Overall length 255 mm
 60 g
No. 719982



2 Usuba, Vegetable Knife
 Blade length 165 mm
 Blade thickness 1.4 mm
 Overall length 305 mm
 135 g
No. 719981

4 Gyuto, Fish and Meat Knife
 Blade length 180 mm
 Blade thickness 1.5 mm
 Overall length 325 mm
 115 g
No. 719983

5 2-Piece Set *Price advantage*
 • Santoku, all-purpose knife (No. 719980)
 • Gyuto, fish and meat knife (No. 719982)
No. 719984

** Thermic wood: Under the effect of heat (170-250 °C) and steam the wood structure is changed and improved for special uses (e.g. in the kitchen) in a targeted and natural way without adding any chemicals. During the special treatment process, the cell wall structure is modified in such a way that the ability to absorb water is reduced and the resistance against bacteria is increased. The thermal treatment also lends the wood a slightly darker tone.*

Inclusive free sharpening pass. For more information see page 4.

 Two free sharpenings



角利
日本製



角利
日本製



播州清網作



HAYASHI

Light and elegant

Aesthetically pleasing knife with a 12-layered blade from Suminagashi steel. The blade is ground very thin and allows you to cut very fine. The handles are made of water-resistant magnolia wood with ferrules of glue-laminated precious wood. Cutting edge of White Paper Steel with a hardness of 60 HRC. Not rustproof, double-bevelled.

A WITHOUT WOODEN SHEATH

1 *Santoku, All-purpose Knife*

Blade length 165 mm
Blade thickness 2.5 mm
Overall length 300 mm
140 g

No. 719207

2 *Gyuto, Fish and Meat Knife*

Blade length 145 mm
Blade thickness 2.5 mm
Overall length 285 mm
90 g

No. 719225

3 *Usuba, Vegetable Knife*

Blade length 165 mm
Blade thickness 2.5 mm
Overall length 305 mm
140 g

No. 719227



4 *3-Piece Set Price advantage*

- Santoku, all-purpose knife (No. 719207)
- Gyuto, fish and meat knife (No. 719225)
- Usuba, vegetable knife (No. 719227)

No. 719433



Edged handle made of magnolia wood, for right-handed use.

B WITH WOODEN SHEATH

1 *Santoku, All-purpose Knife*

Blade length 165 mm
Blade thickness 2.5 mm
Overall length 300 mm
140 g

No. 719112

2 *Gyuto, Fish and Meat Knife*

Blade length 145 mm
Blade thickness 2.5 mm
Overall length 285 mm
90 g

No. 719226

3 *Usuba, Vegetable Knife*

Blade length 165 mm
Blade thickness 2.5 mm
Overall length 305 mm
140 g

No. 719228

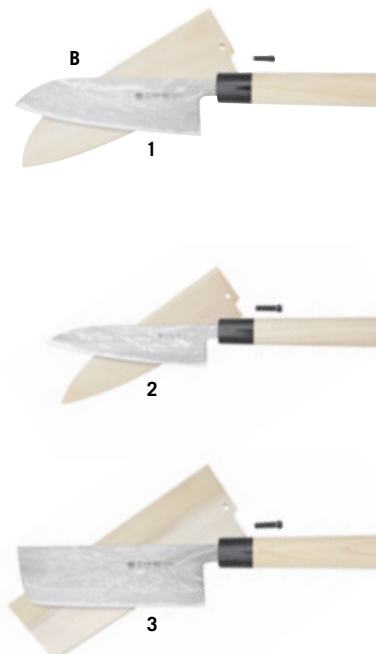

4 *3-Piece Set Price advantage*

- Gyuto, fish and meat knife (No. 719226)
- Santoku, all-purpose knife (No. 719112)
- Usuba, vegetable knife (No. 719228)

No. 719432



Inclusive free sharpening pass.
For more information see page 4.

 Two free sharpenings

JAPANESE KNIFE CONSTRUCTION

A genuine Japanese knife is a highly effective tool that has been crafted by hand, step by step, in a forge. The shape has developed solely out of the intended purpose. Lightweight wooden handles, the well-balanced design and its extraordinary sharpness make using a Hocho an enjoyable experience.

Advantages of using Japanese knives

- **Minimal cutting effort:**
The blades stay sharp for longer and carbon steel in particular is very easy to sharpen.
 - **The blades are wide:**
The rear cutting edge stays sharp.
- ▶ **Differently from Western knives, you can use the full length of the cutting edge**, which is an advantage for both chopping and filleting.

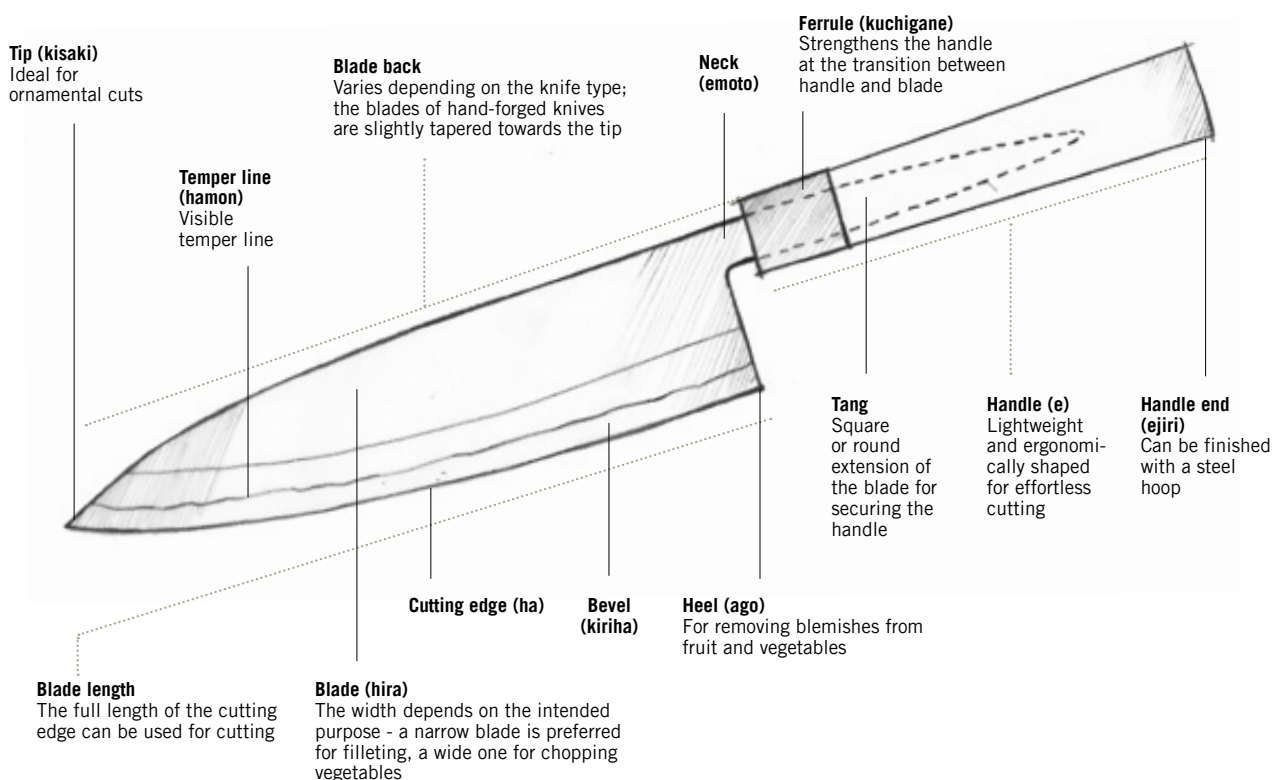

APPLICATION NOTE

In Japan, cooking is understood as the »art of cutting«. Accordingly, the Hocho is a **highly sensitive** and incredibly **sharp tool** that demands **respectful handling**. The blade consists of several layers of steel, whereby the cutting edge is particularly hard and relatively brittle. Thus, avoid any **breaking**, bending and impact stresses on the blade. The knife is not suitable for cutting hard foods such as frozen foods, bones, bread crusts, etc. Avoid tilting the blade and instead try to work with straight, drawn cuts. Rough handling can cause the blades to break.

DESIGN AND HANDLE CONSTRUCTION

There are two different designs: the classic Japanese one with attached handle and the Western one with full-length tang and handle scales. Traditionally designed knives are somewhat lighter and more balanced than Western knives. It is, however, a matter of taste which design you prefer.

• Japanese Design

Classic design with attached wooden handles. These can swell when they get wet and may become loose (light tapping will tighten them again). These knives must be kept dry. As the name suggests, stick tang fixed knives are equipped with a tang (a thin, round or square extension of the blade) that has been inserted into the handle. One of the advantages of this construction is that it is only the handle material that lies in your hand, which makes stick tang fixed knives very pleasant to the touch - in contrast to full tang knives.

There are three different handle shapes:

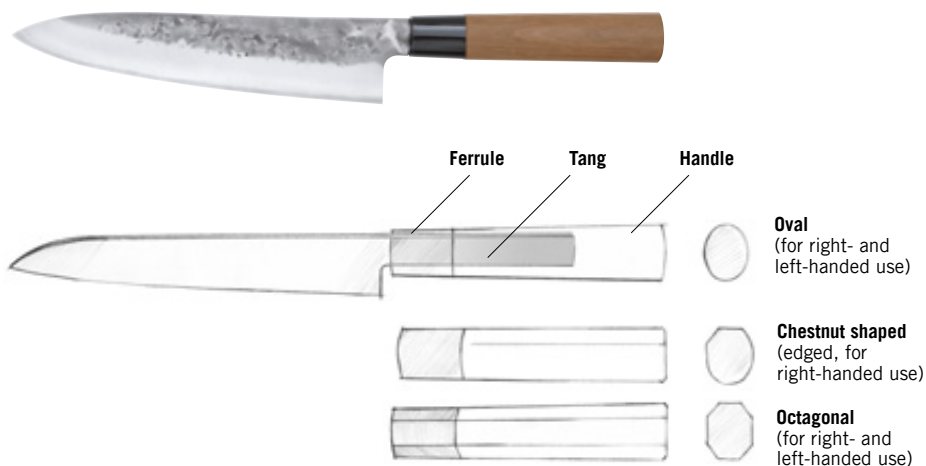

• Western Design

European design with full-length tang and handle scales (integral or semi-integral design). Depending on the material, these knives are normally hard-wearing. However, their centre of gravity is slightly further back and they are usually heavier than classic design knives. Full tang knives feature two handle scales fitted to both sides of the tang. The tang remains visible.

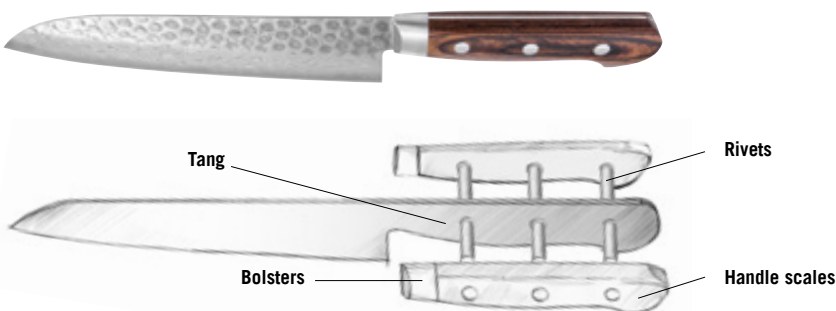

NAKAGOSHI

These traditional Japanese kitchen knives are handmade by Satoshi Nakagoshi and his son in their small workshop on the island Shikoku. The water-resistant magnolia wood handles fit securely in the hand. Cutting edge made of White Paper Steel, not rustproof. Hardness 61 HRC.



Edged handle made of magnolia wood, for right-handed use for all versions except Deba.



FOR RIGHT-HANDERS

A NAKAGOSHI HOCHO

1 Santoku, All-purpose Knife
Three layers, double-bevelled.
Blade length 170 mm
Blade thickness 2.1 mm
Overall length 315 mm
150 g

No. 719482

2 Gyuto, Fish and Meat Knife
Three layers, double-bevelled.
Blade length 115 mm
Blade thickness 2.1 mm
Overall length 235 mm
60 g

No. 719483

3 Gyuto, Fish and Meat Knife
Three layers, double-bevelled.
Blade length 145 mm
Blade thickness 2.1 mm
Overall length 280 mm
80 g

No. 719484

4 Usuba, Vegetable Knife
Two layers, single-bevelled (right-handed use).
Blade length 165 mm
Blade thickness 3 mm
Overall length 300 mm
150 g

No. 719471

5 Sashimi, Fish Knife
Two layers, single-bevelled (right-handed use).
Blade length 150 mm
Blade thickness 3 mm
Overall length 280 mm
80 g

No. 719472

6 Sashimi, Fish Knife
Two layers, single-bevelled (right-handed use).
Blade length 200 mm
Blade thickness 3.5 mm
Overall length 345 mm
125 g

No. 719473

7 Sashimi, Fish Knife
Two layers, single-bevelled (right-handed use).
Blade length 270 mm
Blade thickness 4 mm
Overall length 420 mm
210 g

No. 719474

8 Deba
Two layers, single-bevelled (right-handed use).
Blade length 180 mm
Blade thickness 8 mm
Overall length 330 mm
375 g

No. 719475



9 3-Piece Set *Price advantage*
• Usuba, vegetable knife (No. 719471)
• Santoku, all-purpose knife (No. 719482)
• Sashimi, fish knife (No. 719473)
• Wooden case (No. 705886)
No. 719470



富嶽刃



FOR LEFT-HANDERS

B NAKAGOSHI HOCHO
Double-layered, single bevel (for left-handed use).

1 *Usuba, Vegetable Knife*
Blade length 165 mm
Blade thickness 3 mm
Overall length 300 mm
150 g
No. 719476

2 *Sashimi, Fish Knife*
Blade length 150 mm
Blade thickness 3 mm
Overall length 280 mm
80 g
No. 719477

3 *Sashimi, Fish Knife*
Blade length 200 mm
Blade thickness 3.5 mm
Overall length 345 mm
125 g
No. 719478

4 *Sashimi, Fish Knife*
Blade length 270 mm
Blade thickness 4 mm
Overall length 420 mm
210 g
No. 719479

5 *Deba*
Blade length 180 mm
Blade thickness 8 mm
Overall length 330 mm
375 g
No. 719480

Inclusive free sharpening pass.
For more information see page 4.

 Two free sharpenings

Left-handed, edged
handle made of
magnolia wood for
all versions except
Deba.





RYUSEN
JAPAN

RYUSEN HAMONO

Ryusen Hamono was founded in 1953 in Echizen City, Fukui Prefecture, Japan. The company has been manufacturing exclusive knives for three generations already. Every knife is handmade and therefore unique. Ryusen Hamono was the first company ever to receive the title of »Dentouteki-Kougeihin«, which is an award granted by the Japanese chamber of commerce and industry for traditionally manufactured products.



© For a production video see
www.dictum.com



A PREVER HOCHO

The fascinating appearance of the blade of this timeless, modern kitchen knife is created by a total of 66 folded layers of stainless steel. The cutting layer is made of VG-10, a stainless steel of the highest grade, which is characterised by its excellent edge life. The perfect look of the Japanese knife is completed by an oval handle made of fine walnut wood, which is completed with two polished stainless steel ferrules. All models have a double bevel; the bread knife has a single bevel. Comes in gift box. Suitable wooden sheaths are available separately. Hardness 60 HRC, rustproof.

1 Santoku, All-purpose Knife

Blade length 180 mm
Blade thickness 1.6 mm
Overall length 320 mm
165 g
No. 709930

2 Usuba, Vegetable Knife

Blade length 170 mm
Blade thickness 1.5 mm
Overall length 305 mm
165 g
No. 709931

3 Petty, Small All-purpose Knife

Blade length 105 mm
Blade thickness 1.8 mm
Overall length 220 mm
55 g
No. 709932

4 Gyuto, Fish and Meat Knife

Blade length 150 mm
Blade thickness 1.6 mm
Overall length 260 mm
65 g
No. 709933

5 Gyuto, Fish and Meat Knife

Blade length 210 mm
Blade thickness 1.8 mm
Overall length 350 mm
165 g
No. 709934

6 Gyuto, Fish and Meat Knife

Blade length 235 mm
Blade thickness 1.7 mm
Overall length 375 mm
210 g
No. 709935

7 Sujihiki, Fish and Meat Knife

Blade length 235 mm
Blade thickness 1.6 mm
Overall length 375 mm
150 g
No. 709936

8 Bread Knife

Blade length 240 mm
Blade thickness 1.6 mm
Overall length 395 mm
145 g
No. 709937



Oval-shaped handle made of fine walnut wood, completed with stainless steel ferrules.

Inclusive free sharpening pass.
For more information see page 4.

 Two free sharpenings



9 2-Piece Set *Price advantage*

- Santoku, all-purpose knife (No. 709930)
 - Gyuto, fish and meat knife (No. 709933)
- No. 709938**



RYUSEN
JAPAN

PREVER HOCHO »MAPLE«

The fascinating appearance of the blade of this timeless, modern kitchen knife is created by a total of 66 folded layers of stainless steel. The cutting layer is made of VG-10, a stainless steel of the highest grade, which is characterised by its excellent edge life. The perfect look of the Japanese knife is completed with an oval handle made of spalted, stabilised maple wood, which is finished with two polished stainless steel ferrules. Spalted maple features an intensive grain caused by fungal decay, which makes each knife unique. The wood has been completely impregnated with synthetic resin in a vacuum pressure process and thus stabilised. All models have a double bevel. Comes in gift box. Hardness 60 HRC, rustproof.



Oval-shaped handle made of stabilised maple wood.

A PREVER HOCHO »MAPLE«



Inclusive free sharpening pass.
For more information see page 4.



Two free sharpenings

1 Santoku, All-purpose Knife
Blade length 180 mm
Blade thickness 1.6 mm
Overall length 320 mm
180 g
No. 718690

4 Gyuto, Fish and Meat Knife
Blade length 150 mm
Blade thickness 1.6 mm
Overall length 260 mm
70 g
No. 718693

7 2-Piece Set *Price advantage*
• Santoku, all-purpose knife (No. 718690)
• Petty, small all-purpose knife (No. 718692)
No. 718696

2 Usuba, Vegetable Knife
Blade length 170 mm
Blade thickness 1.5 mm
Overall length 310 mm
180 g
No. 718691

5 Gyuto, Fish and Meat Knife
Blade length 210 mm
Blade thickness 1.8 mm
Overall length 350 mm
180 g
No. 718694



3 Petty, Small All-purpose Knife
Blade length 105 mm
Blade thickness 1.8 mm
Overall length 220 mm
60 g
No. 718692

6 Sujihiki, Fish and Meat Knife
Blade length 240 mm
Blade thickness 1.6 mm
Overall length 375 mm
165 g
No. 718695

8 3-Piece Set *Price advantage*
• Santoku, all-purpose knife (No. 718690)
• Usuba, vegetable knife (No. 718691)
• Petty, small all-purpose knife (No. 718692)
No. 718697

FUKAKU-RYU

Since these slightly structured blades with high-gloss finish are all handmade, every single one of them has a slightly different and very fascinating Damascus steel structure. The Hitachi ATS314 steel* core layer is sandwiched between a total of 62 folded stainless steel outer layers, creating a really fascinating blade pattern. The octagonal shape of the handle is made of vividly figured maple wood. The warm brown colour of the fine-polished wood creates an interesting contrast to the black buffalo horn ferrule. Rustproof, hardness 60 HRC, double-bevelled.

* Steel analysis: C = 1 / Si = 0.3 / Mn = 0.4 / P < 0.03 / S = 0.004 / Co = 1.4 / Cr = 15 / Mo = 1 / V = 0.2 / Ni = 0.15 (in %)



A FUKAKU-RYU HOCHO

1 *Santoku, All-purpose Knife*
 Blade length 175 mm
 Blade thickness 1.9 mm
 Gesamtlänge 315 mm
 130 g
No. 719750

2 *Usuba, Vegetable Knife*
 Blade length 165 mm
 Blade thickness 1.6 mm
 Overall length 310 mm
 145 g
No. 719751



Octagonal handle made of maple wood.



**Inclusive free sharpening pass.
 For more information see page 4.**



Two free sharpenings

FUKAKU-RYU URUSHI HOCHO



Thousands of years of Urushi tradition, combined with an elegant blade to create a unique masterpiece. Each of these tangibly structured blades is unique with its handforged Damascus structure. The Hitachi ATS314 steel* core layer is sandwiched between a total of 62 folded stainless steel outer layers, creating a fascinating blade pattern. The octagonal magnolia wood handle has been refined with an Urushi varnish and impresses with its vermilion/black progression of colour.

風格龍

B FUKAKU-RYU URUSHI HOCHO

*Steel analysis: C = 1 / Si = 0.3 /
Mn = 0.4 / P < 0.03 / S = 0.004 /
Co = 1.4 / Cr = 15 / Mo = 1 / V = 0.2 /
Ni = 0.15 (in %)

1 Santoku, All-purpose Knife
Blade length 130 mm
Blade thickness 1.9 mm
Overall length 260 mm
80 g
No. 709971

2 Santoku, All-purpose Knife
Blade length 170 mm
Blade thickness 1.6 mm
Overall length 305 mm
115 g
No. 709970

3 Usuba, Vegetable Knife
Blade length 130 mm
Blade thickness 2 mm
Overall length 255 mm
100 g
No. 709973

4 Usuba, Vegetable Knife
Blade length 170 mm
Blade thickness 1.7 mm
Overall length 305 mm
130 g
No. 709972

5 Gyuto, Fish and Meat Knife
Blade length 135 mm
Blade thickness 2 mm
Overall length 260 mm
65 g
No. 709974

6 Gyuto, Fish and Meat Knife
Blade length 210 mm
Blade thickness 1.7 mm
Overall length 350 mm
130 g
No. 709975

*Urushi has been extracted from the Asian tea tree (*Rhus vernicifera*) for over 6000 years. It is waterproof, food-safe, resistant to alcohol and solvents, does not become brittle or crack with age and develops a beautiful patina with use.

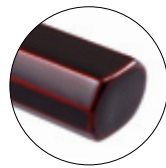

Octagonal magnolia wood handle, refined with an Urushi* varnish.



7 2-Piece Set Price advantage

- Santoku, all-purpose knife (No. 709970)
- Gyuto, fish and meat knife (No. 709974)

No. 709976

C WOODEN SHEATH FOR FUKAKU-RYU URUSHI HOCHO
The wooden sheaths made of magnolia wood (*Magnolia obovata*) are finished with a vermilion/black Urushi varnish.

Fits
709971 **No. 709978**
1 709970 **No. 709977**
709973 **No. 709980**
2 709972 **No. 709979**
709974 **No. 709981**
3 709975 **No. 709982**

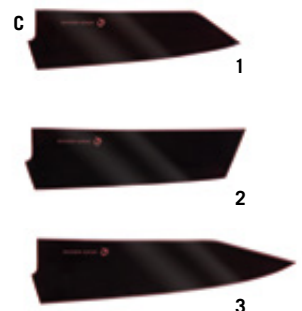



BLAZEN RYU-WA

Fine hammer marks decorate the upper part of the hand-forged triple-layered blades. The core cutting layer made of powder-metallurgically produced SG-2 steel gives this knife an extraordinary sharpness and edge-holding capacity. Fine walnut wood is used for the octagonal handle. Rustproof, double bevel, hardened to 62 HRC.

A



1



2



3

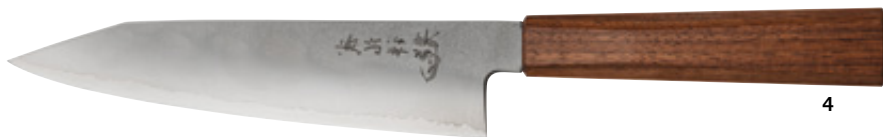

4

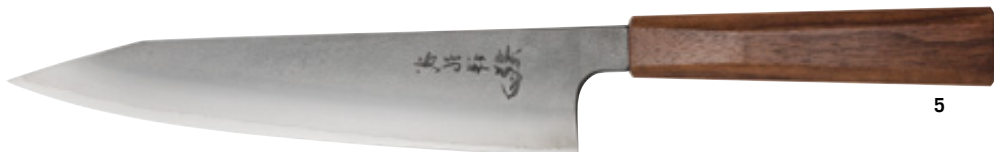

5



A BLAZEN RYU-WA HOCHO

1 Santoku, All-purpose Knife
Blade length 170 mm
Blade thickness 3.1 mm
Overall length 210 mm
125 g
No. 708950

2 Usuba, Vegetable Knife
Blade length 170 mm
Blade thickness 2 mm
Overall length 310 mm
150 g
No. 708951

3 Gyuto, Fish and Meat Knife
Blade length 135 mm
Blade thickness 1.8 mm
Overall length 260 mm
55 g
No. 708952

4 Gyuto, Fish and Meat Knife
Blade length 180 mm
Blade thickness 2 mm
Overall length 320 mm
115 g
No. 708953

5 Gyuto, Fish and Meat Knife
Blade length 210 mm
Blade thickness 1.8 mm
Overall length 355 mm
125 g
No. 708954



Octagonal handle made of walnut wood.



► For a Gyuto with blade length 240 mm (No. 708957) see www.dictum.com



6



7



6 2-Piece Set *Price advantage*
• Santoku, all-purpose knife (No. 708950)
• Gyuto, fish and meat knife (No. 708952)
No. 708955

7 3-Piece Set *Price advantage*
• Santoku, all-purpose knife (No. 708950)
• Usuba, vegetable knife (No. 708951)
• Gyuto, fish and meat knife (No. 708952)
No. 708956

武孔祥
龍



丹巖龍



TANGANRYU

A successful combination of modern design, traditional blade shape and high-quality materials. The knives are available with three different handle materials, to choose from: Linen Micarta, maple and walnut wood. The Damascus structure of the lower part of the blade contrasts beautifully with the hammered surface structure of the upper part, which also ensures that the material to be cut does not stick to the blade. The stainless steel handle end piece also has a matching hammered surface. A total of 66 folded outer layers of stainless steel create a fascinating appearance. The cutting layer is made of VG-10, a rustproof steel of the highest grade, which is characterised by its excellent edge life. All models have a double bevel; the bread knife has a single bevel. Comes in gift box. Suitable wooden sheaths are available separately. Hardness 60 HRC, rustproof.

A TANGANRYU HOCHO, MAPLE
 Square handle made of attractive maple wood, without rivets, surface lacquered.



1 Santoku, All-purpose Knife

Blade length 170 mm
 Blade thickness 2.1 mm
 Overall length 315 mm
 175 g
No. 709940

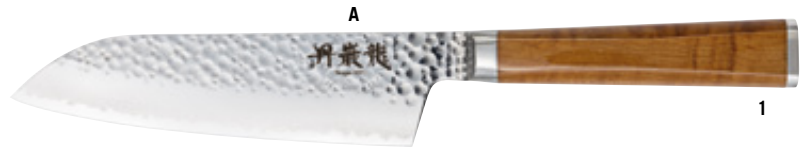

2 Usuba, Vegetable Knife

Blade length 170 mm
 Blade thickness 2.1 mm
 Overall length 305 mm
 190 g
No. 709941



3 Petty, Small All-purpose Knife

Blade length 105 mm
 Blade thickness 2 mm
 Overall length 220 mm
 60 g
No. 709942



4 Gyuto, Fish and Meat Knife

Blade length 135 mm
 Blade thickness 2.2 mm
 Overall length 250 mm
 70 g
No. 709943



5 Gyuto, Fish and Meat Knife

Blade length 150 mm
 Blade thickness 2 mm
 Overall length 270 mm
 80 g
No. 709944



6 Gyuto, Fish and Meat Knife

Blade length 180 mm
 Blade thickness 2.1 mm
 Overall length 320 mm
 165 g
No. 709945

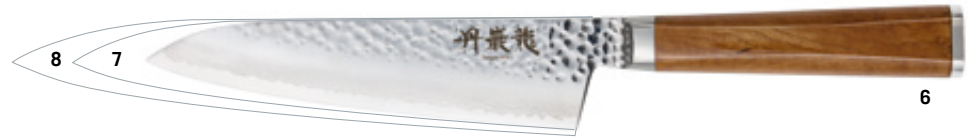

7 Gyuto, Fish and Meat Knife

Blade length 210 mm
 Blade thickness 2.1 mm
 Overall length 350 mm
 175 g
No. 709946



8 Gyuto, Fish and Meat Knife

Blade length 240 mm
 Blade thickness 2.2 mm
 Overall length 380 mm
 215 g
No. 709947



9 Sujihiki, Fish and Meat Knife

Blade length 240 mm
 Blade thickness 2.1 mm
 Overall length 380 mm
 170 g
No. 709948



10 Bread Knife

Blade length 210 mm
 Blade thickness 2 mm
 Overall length 350 mm
 140 g
No. 709949

► For a Sujihiki with blade length 270 mm (No. 709951) see www.dictum.com



Stainless steel handle end piece with hammered surface.

11 2-Piece Set *Price advantage*

- Santoku, all-purpose knife (No. 709940)
- Gyuto, fish and meat knife (No. 709943)

No. 709950



1



2



3



4



5



6



9



10

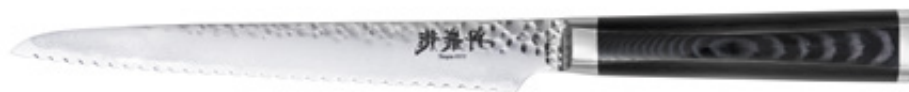

11



12

12 2-Piece Set *Price advantage*
 • Gyuto, fish and meat knife (No. 719491)
 • Santoku, all-purpose knife (No. 719490)
No. 719495

A TANGANRYU HOCHO,
 LINEN MICARTA
 Square handle made of water-resistant linen micarta, without rivets, black/grey grain.

1 *Santoku, All-purpose Knife*
 Blade length 165 mm
 Blade thickness 2 mm
 Overall length 310 mm
 200 g
No. 719490

2 *Usuba, Vegetable Knife*
 Blade length 160 mm
 Blade thickness 2 mm
 Overall length 310 mm
 200 g
No. 719494

3 *Petty, Small All-purpose Knife*
 Blade length 105 mm
 Blade thickness 2.1 mm
 Overall length 220 mm
 75 g
No. 709952

4 *Gyuto, Fish and Meat Knife*
 Blade length 135 mm
 Blade thickness 2 mm
 Overall length 250 mm
 80 g
No. 719491

5 *Gyuto, Fish and Meat Knife*
 Blade length 150 mm
 Blade thickness 2 mm
 Overall length 270 mm
 90 g
No. 709953

6 *Gyuto, Fish and Meat Knife*
 Blade length 180 mm
 Blade thickness 2 mm
 Overall length 315 mm
 180 g
No. 719492

7 *Gyuto, Fish and Meat Knife*
 Blade length 210 mm
 Blade thickness 2 mm
 Overall length 345 mm
 200 g
No. 719493

8 *Gyuto, Fish and Meat Knife*
 Blade length 240 mm
 Blade thickness 2.2 mm
 Overall length 380 mm
 255 g
No. 709954

9 *Sujihiki, Fish and Meat Knife*
 Blade length 240 mm
 Blade thickness 2.1 mm
 Overall length 380 mm
 200 g
No. 709955

10 *Sujihiki, Fish and Meat Knife*
 Blade length 270 mm
 Blade thickness 2.1 mm
 Overall length 420 mm
 260 g
No. 709957

11 *Bread Knife*
 Blade length 210 mm
 Blade thickness 2 mm
 Overall length 350 mm
 165 g
No. 709956



Stainless steel handle end piece with hammered surface.

Inclusive free sharpening pass.
For more information see page 4.

Two free sharpenings



風格龍



Octagonal handle made of flamed maple wood.

B



B FUKAKU-RYU HOCHO, MAPLE

Each of these blades with exciting patterns is unique thanks to its handforged Damascus structure. The Hitachi ATS314 steel* core layer is sandwiched between a total of 62 folded stainless steel outer layers, creating a fascinating blade pattern. Flamed maple wood is used for the elegant octagonal handle. Comes in a gift box. Rustproof, hardness 61 HRC, double bevel.

1 Santoku, All-purpose Knife
Blade length 170 mm
Blade thickness 1.6 mm
Overall length 315 mm
115 g
No. 708982

2 Usuba, Vegetable Knife
Blade length 170 mm
Blade thickness 1.5 mm
Overall length 310 mm
130 g
No. 708983

3 Gyuto, Fish and Meat Knife
Blade length 135 mm
Blade thickness 1.8 mm
Overall length 260 mm
55 g
No. 708984

4 Gyuto, Fish and Meat Knife
Blade length 210 mm
Blade thickness 1.3 mm
Overall length 350 mm
125 g
No. 708985

5 Sujihiki, Fish and Meat Knife
Blade length 270 mm
Blade thickness 2 mm
Overall length 425 mm
150 g
No. 708986

► For a Gyuto with blade length 240 mm (No. 708989) see www.dictum.com

* Steel analysis: C = 1 / Si = 0.3 / Mn = 0.4 / P < 0.03 / S = 0.004 / Co = 1.4 / Cr = 15 / Mo = 1 / V = 0.2 / Ni = 0.15 (in %)



6 2-Piece Set Price advantage
• Santoku, all-purpose knife (No. 708982)
• Gyuto, fish and meat knife (No. 708984)
No. 708987

7 3-Piece Set Price advantage
• Santoku, all-purpose knife (No. 708982)
• Usuba, vegetable knife (No. 708983)
• Gyuto, fish and meat knife (No. 708984)
No. 708988

楚文雲龍

BONTENUNRYU

Each of these blades with exciting patterns is unique thanks to its handforged Damascus structure. A total of 62 folded, rustproof outer layers surround the cutting layer of VG-10 steel, a rustproof steel of the highest quality, which is characterised by its long edge life. The handle scales made of black pakka wood are triple riveted to the tang with stainless steel pins and completed with polished stainless steel bolsters. Comes in a gift box. Suitable wooden sheaths are available separately. Rustproof, hardness 60 HRC, double bevel.



A BONTENUNRYU HOCHO

1 Santoku, All-purpose Knife
 Blade length 170 mm
 Blade thickness 2.1 mm
 Overall length 295 mm
 190 g
No. 708700

2 Usuba, Vegetable Knife
 Blade length 170 mm
 Blade thickness 1.7 mm
 Overall length 295 mm
 200 g
No. 708701

3 Petty, Small All-purpose Knife
 Blade length 75 mm
 Blade thickness 1.3 mm
 Overall length 180 mm
 60 g
No. 708702

4 Petty, Small All-purpose Knife
 Blade length 95 mm
 Blade thickness 1.5 mm
 Overall length 200 mm
 70 g
No. 708703

5 Gyuto, Fish and Meat Knife
 Blade length 130 mm
 Blade thickness 1.6 mm
 Overall length 235 mm
 80 g
No. 708704

6 Gyuto, Fish and Meat Knife
 Blade length 150 mm
 Blade thickness 1.6 mm
 Overall length 255 mm
 90 g
No. 708705

7 Gyuto, Fish and Meat Knife
 Blade length 180 mm
 Blade thickness 1.8 mm
 Overall length 300 mm
 170 g
No. 708707

8 Gyuto, Fish and Meat Knife
 Blade length 210 mm
 Blade thickness 1.8 mm
 Overall length 335 mm
 190 g
No. 708708

9 Gyuto, Fish and Meat Knife
 Blade length 240 mm
 Blade thickness 1.6 mm
 Overall length 370 mm
 240 g
No. 708709



Inclusive free sharpening pass.
For more information see page 4.



Two free sharpenings



7



12



13



14

10 Gyuto, Fish and Meat Knife
 Blade length 270 mm
 Blade thickness 2 mm
 Overall length 405 mm
 310 g
No. 708710

12 Sujihiki, Fish and Meat Knife
 Blade length 235 mm
 Blade thickness 1.5 mm
 Overall length 360 mm
 170 g
No. 708712

13 Sujihiki, Fish and Meat Knife
 Blade length 270 mm
 Blade thickness 1.5 mm
 Overall length 400 mm
 220 g
No. 708713

14 Slicer, Fish and Meat Knife
 Blade length 240 mm
 Blade thickness 1.5 mm
 Overall length 370 mm
 200 g
No. 708714

11 Gyuto, Fish and Meat Knife
 Blade length 300 mm
 Blade thickness 1.9 mm
 Overall length 430 mm
 340 g
No. 708711



15

15 Bontenunryu Hocho, 2-Piece Set *Price advantage*
 • Santoku, all-purpose knife (No. 708700)
 • Gyuto, fish and meat knife (No. 708705)
No. 708715



16

16 3-Piece Set *Price advantage*
 • Santoku, all-purpose knife (No. 708700)
 • Usuba, vegetable knife (No. 708701)
 • Gyuto, fish and meat knife (No. 708705)
No. 708716

慧
天
雲
龍

BONTENUNRYU WENGE

The expressive, wavy blade pattern is created by a total of 63 folded layers of steel. The core cutting layer is made of VG-10, a rustproof steel of the highest grade, which is characterised by its excellent edge life. It harmonises perfectly with the octagonal handle made of wenge, a wood with an extraordinary light-dark structure. A black laminated wood ferrule forms the transition to the blade. Comes in gift box. Rustproof, hardness 60 HRC, double bevel.



A BONTENUNRYU HOCHO, WENGE



1 Santoku, All-purpose Knife
Blade length 170 mm
Blade thickness 2 mm
Overall length 310 mm
130 g
No. 708940

2 Usuba, Vegetable Knife
Blade length 165 mm
Blade thickness 1.8 mm
Overall length 310 mm
160 g
No. 708941

3 Gyuto, Fish and Meat Knife
Blade length 135 mm
Blade thickness 1.6 mm
Overall length 260 mm
60 g
No. 708942

4 Gyuto, Fish and Meat Knife
Blade length 180 mm
Blade thickness 1.7 mm
Overall length 315 mm
130 g
No. 708943

5 Gyuto, Fish and Meat Knife
Blade length 210 mm
Blade thickness 1.6 mm
Overall length 355 mm
140 g
No. 708944

6 Gyuto, Fish and Meat Knife
Blade length 240 mm
Blade thickness 1.5 mm
Overall length 390 mm
170 g
No. 708945

7 Sujihiki, Fish and Meat Knife
Blade length 240 mm
Blade thickness 1.9 mm
Overall length 380 mm
110 g
No. 708946

8 Sujihiki, Fish and Meat Knife
Blade length 270 mm
Blade thickness 2 mm
Overall length 430 mm
180 g
No. 708947



9 2-Piece Set Price advantage
• Santoku, all-purpose knife (No. 708940)
• Gyuto, fish and meat knife (No. 708942)
No. 708948



10 3-Piece Set Price advantage
• Santoku, all-purpose knife (No. 708940)
• Usuba, vegetable knife (No. 708941)
• Gyuto, fish and meat knife (No. 708942)
No. 708949

Inclusive free sharpening pass.
For more information see page 4.



Two free sharpenings



Octagonal handle made of wenge.

THE VARIETY OF BLADE STRUCTURES

All knives are not the same. And all steels are not the same. Different techniques in forging and finishing a blade result in a wide range of structures and surface textures. Every blacksmith has his own method and every hand-forged knife is therefore unique. The original surface of a knife is the black forged skin, which gives it a rustic appearance and protects the blade from rust.



Vividly grained rose Damascus, glossy

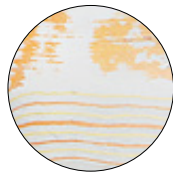

Precious Damascus structure made of copper and brass, satin-finish



Roughly hammered surface, slightly glossy

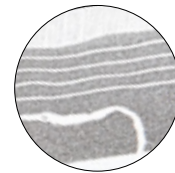

Dark Suminagashi pattern, satin-finish

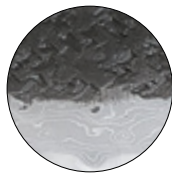

Lightly hammered surface with black forged skin

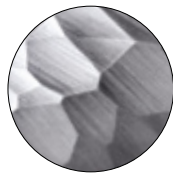

Ground surface, satin-finish

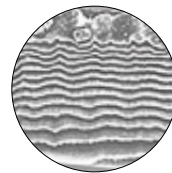

Vivid Suminagashi surface, matt finish



Polished surface, glossy

BRIEF GLOSSARY OF STEEL TERMS

White Paper Steel (Shiro Gami)

Trade name for a highly pure carbon steel made by Hitachi (Japan), mainly used for making cutting tools. This steel is particularly hard and has an especially fine martensitic structure. This means you can grind it to exceptional sharpness, which retains for a long time. Not rustproof.
 $C = 1.2 / Si = 0.2 / Mn = 0.2 / P < 0.02 / S < 0.004$

Blue Paper Steel (Ao Gami)

Similar to White Paper Steel but alloyed with additional 0.4 % chromium and 1.5 % tungsten. This makes it somewhat tougher. Not rustproof.
 $C = 1.2 / Si = 0.2 / Mn = 0.2 / P < 0.02 / S < 0.004 / Cr = 0.4 / W = 1.5$

VG-10

Rustproof high-class blade steel, made by Takefu (Japan). Extremely tough and durable due to high content of cobalt.

$C = 1 / Si = 0.6 / Mn = 0.5 / P < 0.03 / S < 0.03 / Co = 1.5 / Cr = 15 / Mo = 1 / V = 0.2$

D2

Extremely sharp and wear-resistant. This steel features a chromium content of 12 % and is therefore designated as a so called rust-resistant steel.
 $C = 1.5 / Si = 0.6 / Mn = 0.6 / P < 0.03 / S < 0.03 / Cr = 12 / Mo = 0.8 / V = 0.9$

Böhler N690

Rust-resistant steel with cobalt, molybdenum and vanadium. Finely structured, tough and wear-resistant steel.
 $C = 1.05 / Si = 0.4 / Mn = 0.4 / Co = 1.5 / Cr = 17 / Mo = 0.5$

VG-1

Rust-resistant steel, made by Takefu (Japan). Enhanced toughness due to its nickel content.
 $C = 0.95 - 1.05 / Si < 0.5 / Mn < 0.5 / P < 0.03 / S < 0.03 / Cr = 13-15 / Mo = 0.2-0.4 / Ni < 0.25 / Cu < 0.25$

SLD

Japanese steel made by Hitachi which guarantees excellent sharpness and wear-resistance due to its high carbon content. It has a chrome content of 12 % and is therefore rust-resistant.

$C = 1.5 / Si = 0.25 / Mn = 0.4 / Cr = 12 / Mo = 1 / V = 0.35$

Sandvik 12C27

Rust-resistant blade steel made in Sweden. The company Sandvik continuously improved this steel over a period of 45 years which evolved the 12C27 steel into the high performing steel grade it is today. It is very popular for making hunting and folding knives.

$C = 0.6 / Si = 0.4 / Mn = 0.4 / P = 0.03 / S = 0.01 / Cr = 13.5 / Mo = 3 / V = 2$

Sandvik 19C27

Swedish blade steel made by the steel manufacturer Sandvik. A rust-resistant steel with a high content of carbon, very good wear-resistance.

$C = 0.95 / Si = 0.4 / Mn = 0.65 / P = 0.025 / S = 0.01 / Cr = 13.5$

CPM S35VN

A powder-metallurgically manufactured premium knife steel. The steel has an excellent combination of wear- and corrosion-resistance.

$C = 1.4 / Cr = 14 / Mo = 2 / V = 3 / Nb = 0.5$

ATS34

A very pure, rustproof steel made in Japan that displays a very fine crystalline structure due to its high molybdenum content.

$C = 1 / Si = 0.35 / Mn = 0.4 / P = 0.03 / S = 0.02 / Cr = 14 / Mo = 4$

C75

Spring steel with high carbon content, easy to re-sharpen.

$C = 0.75 / Si = 0.25 / Mn = 0.7$

Damasteel® DS93X™

Rust-resistant, powder-metallurgically manufactured Damascus steel, composed of RWL34 (»light-coloured«) and PMC-27 (»dark-coloured«).

RWL-34:

$C = 1.05 / Si = 0.5 / Mn = 0.5 / P = 0.05 / S = 0.03 / Cr = 14 / Mo = 4 / V = 0.2$

PMC-27:

$C = 0.6 / Si = 0.5 / Mn = 0.5 / Co = 13.5$

Damasteel® RWL34™

Rust-resistant, powder-metallurgically manufactured steel, made by Swedish steel manufacturer Damasteel, based on the well-known knife steel ATS34. The powder-metallurgical manufacturing process allows for a precise chemical composition.

$C = 1.05 / Si = 0.5 / Mn = 0.5 / P = 0.05 / S = 0.03 / Cr = 14 / Mo = 4 / V = 0.2$

440 Steel

A description for rustproof steels which are often used in the knife making industry and which are separated in three categories. The steels 440A, 440B (1.4112) and 440C (1.4125) differ by their carbon content.

440A:

$C = 0.7 / Si = 1 / Mn = 1 / P = 0.04 / S = 0.03 / Cr = 17 / Mo = 0.75$

440B:

$C = 0.85 / Si = 1 / Mn = 1 / P = 0.04 / S = 0.03 / Cr = 17 / Mo = 0.75$

440C:

$C = 1 / Si = 1 / Mn = 1 / P = 0.04 / S = 0.03 / Cr = 17 / Mo = 0.75$

AUS Steel

The Japanese, rust-resistant steels AUS-6 and AUS-8 are comparable to the European 440 steels concerning their characteristics. These steels are mainly differing by their carbon content.

AUS-6:

$C = 0.6 / Si = 1 / Mn = 1 / P = 0.04 / S = 0.03 / Cr = 14 / V = 0.2 / Ni = 0.49$

AUS-8:

$C = 0.7 / Si = 1 / Mn = 0.5 / P = 0.04 / S = 0.03 / Cr = 14 / Mo = 0.2 / V = 0.2 / Ni = 0.49$

GIN 1

Rust-resistant blade steel made by Hitachi (Japan). Particularly corrosion- and wear-resistant due to its high chromium content.

$C = 0.9 / Si = 0.35 / Mn = 0.6 / P < 0.02 / S < 0.03 / Cr = 15.5 / Mo = 0.3$

SG-2

Rust-resistant heavy-duty steel, made using a powder-metallurgical process. Specially developed for kitchen knives.

$C = 1.3 / P < 0.02 / S < 0.02 / Cr = 15 / Mo = 3 / V = 2$

PM Steel

Sintering allows metals which normally cannot be alloyed or welded together to be combined. The components are mixed in powdered form and then hot isostatically pressed in a process known as Powder Metallurgy (PM). These rust-resistant steels even outperform low alloyed steels in terms of hardness. However, they cannot be ground as fine as low alloyed carbon steels (e.g. White Paper Steel).

Suminagashi

Traditional Japanese Damascus steel. Japanese Damascus steels are mostly offered as multi-layered steels with core layers of White or Blue Paper Steel or VG-10 steel.

All alloy constituents are stated in percent (%).

C	Carbon	Mo	Molybdenum
Si	Silicon	V	Vanadium
Mn	Manganese	W	Tungsten
P	Phosphorus	Ni	Nickel
S	Sulfur	Cu	Copper
Co	Cobalt	Nb	Niobium
Cr	Chromium		

IT IS ALL A MATTER OF CHOOSING THE RIGHT STEEL!

Traditionally designed Japanese knives are forged in multiple layers of carbon steel with one or more layers of iron. The hard carbon steel is forge-welded with tough iron, a construction which is similar to the multi-layered swords of the Samurai. Only this elaborate procedure ensures an optimum synthesis of breaking strength and ultimate sharpness.

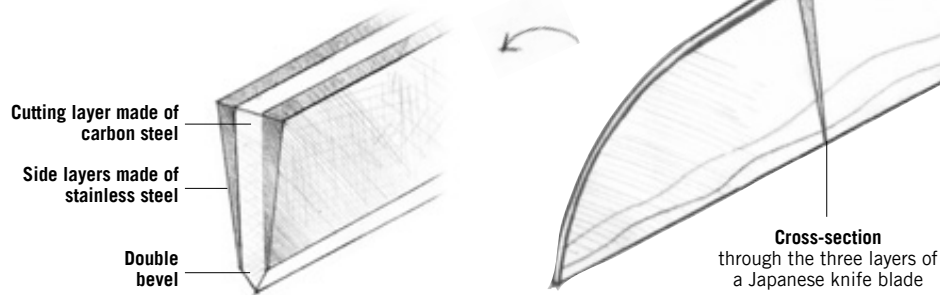

Although carbon steel is not rustproof, it offers ultimate sharpness and edge life and is easy to sharpen.

Today, not only carbon steels but also alloyed steels and powder metallurgically produced steels (PM steels) are used for knife making. They are rustproof and thus easier to care for, but also harder to sharpen. The right choice of steel therefore depends on one's demands and on how much time one is willing to invest in knife care.



- **Classic carbon steel (one or more layers)** is not rustproof.

The unalloyed steel has a very high degree of purity, is especially hard and has a fine martensitic structure. It can therefore reach an extraordinary sharpness and holds this sharpness for a long time. The blade needs to be rinsed and dried after use. Oil it occasionally to prevent it from tarnishing.

- **Cutting layer made of carbon steel, embedded between several layers of stainless steel (triple- or multi-layered)** The blade is rustproof except for the exposed part of the cutting layer, which may oxidise. A good compromise between maintenance requirements and sharpenability. Features of the cutting layer are similar to those described under »Classic carbon steel«.

- **Stainless steel (one or more layers)** is rustproof and does not need to be oiled. The high chromium content, however, reduces the sharpenability. Chromium tends to clog the sharpening stone and increases burr formation. These knives are also unfit for the dishwasher.

Knives with a double bevel are suitable for right- and left-handed use. One important issue to consider is whether the handles are also designed for right- and left-handed use. An edged handle may be uncomfortable for left-handed use.

Knives with a single bevel are suitable for right- or left-handed use. They feature a hollow grind on the flat side of the blade which creates a kind of air cushion between the blade and the material being cut. The alternating hollows ensure minimal friction and allow for precise filleting and more accurate cuts.

THE DREAM OF EVERY SWORDSMITH

Tamahagane: Japanese masters made the queen of blades from this amorphous material. The Japanese sword steel is made melting the purest ore sand (Masa) and pine charcoal. This days-long process called »Tatara« is the first known manufacturing method, where steel is extracted directly from the raw material, without any intermediate steps. Tamahagane has the highest degree of purity of all known steels. We have a small amount of this precious material, which formed the basis of over 1000 years of high culture of forging swords.



ZUIKA

These Japanese Hocho from the historic Gihei house are forged from one of the world's hardest blade steels. The core cutting layer is made of Hitachi's powder-metallurgical premium steel ZDP-189, which provides extreme sharpness and durability due to its very high carbon content of 3 %. The blade's 20 % chromium content makes it rustproof and easy to clean. The extremely hard cutting steel is covered by two tougher stainless steel layers (SUS405), making the knife highly break-resistant. The octagonal handle made from Japanese zelkove has a wonderful yellow-brown colour and is completed with a buffalo horn ferrule. The double-bevelled blades bear the master's engraved signature. Hardness 66 HRC.



瑞
次
代

 **A ZUIKA HOCHO**

1 Santoku, All-Purpose Knife
Blade length 160 mm
Blade thickness 2 mm
Overall length 300 mm
130 g
No. 719710

2 Usuba, Vegetable Knife
Blade length 160 mm
Blade thickness 1.7 mm
Overall length 300 mm
150 g
No. 719712

Inclusive free sharpening pass.
For more information see page 4.

 Two free sharpenings

 Lifetime sharpening

3 Gyuto, Fish and Meat Knife
Blade length 150 mm
Blade thickness 2 mm
Overall length 290 mm
105 g
No. 719711



Octagonal handle made of Japanese zelkove.



GYUTO BM1

Each knife is unique. This knife is a combination of two high-quality materials - and not just visually. The varied natural texture of the birch bark handle made of bm1 and the vivid blade of 15-layered Damascus steel make the perfect combination. The bm1* handle not only has a pleasantly smooth, warm feel but also boasts unique technical qualities. An extremely durable natural material with high stability at a low weight, it is water-repellent, keeps its shape extremely well and is slip-proof even when wet. Its antibacterial effect, due to the natural ingredients of birch bark, is particularly important in the kitchen. The cutting edge of the 15-layered Damascus blade is made of White Paper Steel with a hardness of 61 HRC. Not rustproof, double-bevelled.

* Birch bark, bm1

Each product made of bm1 is unique. Made from numerous individual layers of birch bark, this is a vivid material whose colour, growth pattern and texture vary greatly. A patented manufacturing process tailored to the material characteristics of birch bark allows high stability at a low weight. Compared to other natural materials, bm1 keeps its shape extremely well, especially when exposed to moisture.

 **B** GYUTO WITH BIRCH BARK HANDLE

Blade length 180 mm
Blade thickness 1.5 mm
Overall length 315 mm
120 g
No. 719730

KUROSAKI

Hand-forged knives made by the Japanese master smith Yu Kurosaki. Distinct traces of hammering adorn the upper part of the triple-layered blade, giving it excellent purchase as it moves through material while also producing an attractive look. The cutting core is made of rustproof SG-2 steel. This is one of the hardest steels used in kitchen knives worldwide and manufactured using powder metallurgy techniques. This hard steel is enclosed within two softer layers of rustproof steel to ensure stability. An octagonal sandalwood handle with a black laminated wood ferrule adds the finishing touches to the perfect knife. Signed, rustproof blade, double-bevelled, hardened to 63 HRC.



A KUROSAKI HOCHO

1 Santoku, All-purpose Knife
Blade length 170 mm
Blade thickness 1.8 mm
Overall length 310 mm
130 g
No. 719890

4 Gyuto, Fish and Meat Knife
Blade length 120 mm
Blade thickness 1.5 mm
Overall length 250 mm
65 g
No. 719893

2 Bunka, All-purpose Knife
Blade length 160 mm
Blade thickness 1.8 mm
Overall length 305 mm
125 g
No. 719891

5 Gyuto, Fish and Meat Knife
Blade length 145 mm
Blade thickness 1.6 mm
Overall length 275 mm
80 g
No. 719894

3 Usuba, Vegetable Knife
Blade length 165 mm
Blade thickness 1.8 mm
Overall length 310 mm
160 g
No. 719892

6 Gyuto, Fish and Meat Knife
Blade length 210 mm
Blade thickness 1.8 mm
Overall length 360 mm
160 g
No. 719895



Octagonal handle
made of brown
sandalwood.

7 Gyuto, Fish and Meat Knife
Blade length 240 mm
Blade thickness 1.8 mm
Overall length 400 mm
180 g
No. 719896



越前
黒崎
優

8



8 2-Piece Set *Price advantage*
 • Santoku, all-purpose knife (No. 719890)
 • Gyuto, fish and meat knife (No. 719893)
No. 719897

Inclusive free sharpening pass.
 For more information see page 4.



Two free sharpenings



SG-2 steel,
rustproof



31 layers,
rustproof

佐治武士作

SAJI

Takeshi Saji is among the most famous master smiths in the Takefu Knife Village. With a high-contrast look, this eye-catching blade consists of 31 layers in total. The cutting edge made of SG-2 steel manufactured using powder metallurgy lends it an exceptional sharpness and edge retention. The desert ironwood handle scales, designed specifically with European hands in mind, are fitted to the one-piece blade. Sourced in the deserts of Arizona, the Olneya tree grows at an exceptionally slow pace to produce desert ironwood, one of the world's hardest and densest timbers. The exquisitely beautiful grain shows a golden brown hue with dark streaks. Its high density makes the wood particularly resistant to moisture. One mosaic pin and two stainless steel pins add the finishing touches to the look of this delightful knife. Polished stainless steel flanges fit the blade, which bears the master's engraved signature. Rustproof, double-bevelled, hardness 63 HRC. Supplied in a box made of kiri wood.



 **A SAJI HOCHO**

1 Santoku, All-purpose Knife
Blade length 180 mm
Blade thickness 1.8 mm
Overall length 310 mm
235 g
No. 719840



2 Usuba, Vegetable Knife
Blade length 170 mm
Blade thickness 1.7 mm
Overall length 295 mm
235 g
No. 719841



3 Gyuto, Fish and Meat Knife
Blade length 135 mm
Blade thickness 1.1 mm
Overall length 250 mm
125 g
No. 719842



4 Gyuto, Fish and Meat Knife
Blade length 180 mm
Blade thickness 1.4 mm
Overall length 310 mm
190 g
No. 719843



5 Gyuto, Fish and Meat Knife
Blade length 210 mm
Blade thickness 1.5 mm
Overall length 340 mm
210 g
No. 719844



6 Gyuto, Fish and Meat Knife
Blade length 240 mm
Blade thickness 1.8 mm
Overall length 380 mm
270 g
No. 719845



7 Sujihiki, Fish and Meat Knife
Blade length 270 mm
Blade thickness 1.8 mm
Overall length 410 mm
250 g
No. 719846



8



8 2-Piece Set *Price advantage*
• Santoku, all-purpose knife (No. 719840)
• Gyuto, fish and meat knife (No. 719842)
• Casket with sliding lid
No. 719847



Inclusive free sharpening pass.
For more information see page 4.

 Lifetime sharpening



SAJI RAINBOW

Takeshi Saji is one of the most famous master blacksmiths from Takefu Knife Village. This high-contrast blade made of 11 layers of Suminagashi steel possesses a cutting core made of Blue Paper Steel, which is known for its sharpness and ability to hold an edge. For the outer layers, the smith uses a combination of copper, brass, and stainless steel to create a fascinating blade pattern. The handle scales made from black linen micarta are mounted on the single-piece blade and dimensioned to be comfortable even for European hands. Micarta is created using a special high-pressure process that combines linen with epoxy resin. This material is practically indestructible and resistant to acids and oils. The handle is both anti-slip and comfortable to hold - even in cold, wet conditions. A mosaic pin and two stainless steel pins round off its perfect appearance. Flanges of polished stainless steel form the transition to the blade, which is signed by the master with an engraving stylus. Not rustproof, double-bevelled, hardness 64 HRC. Comes in a kiri wood case.

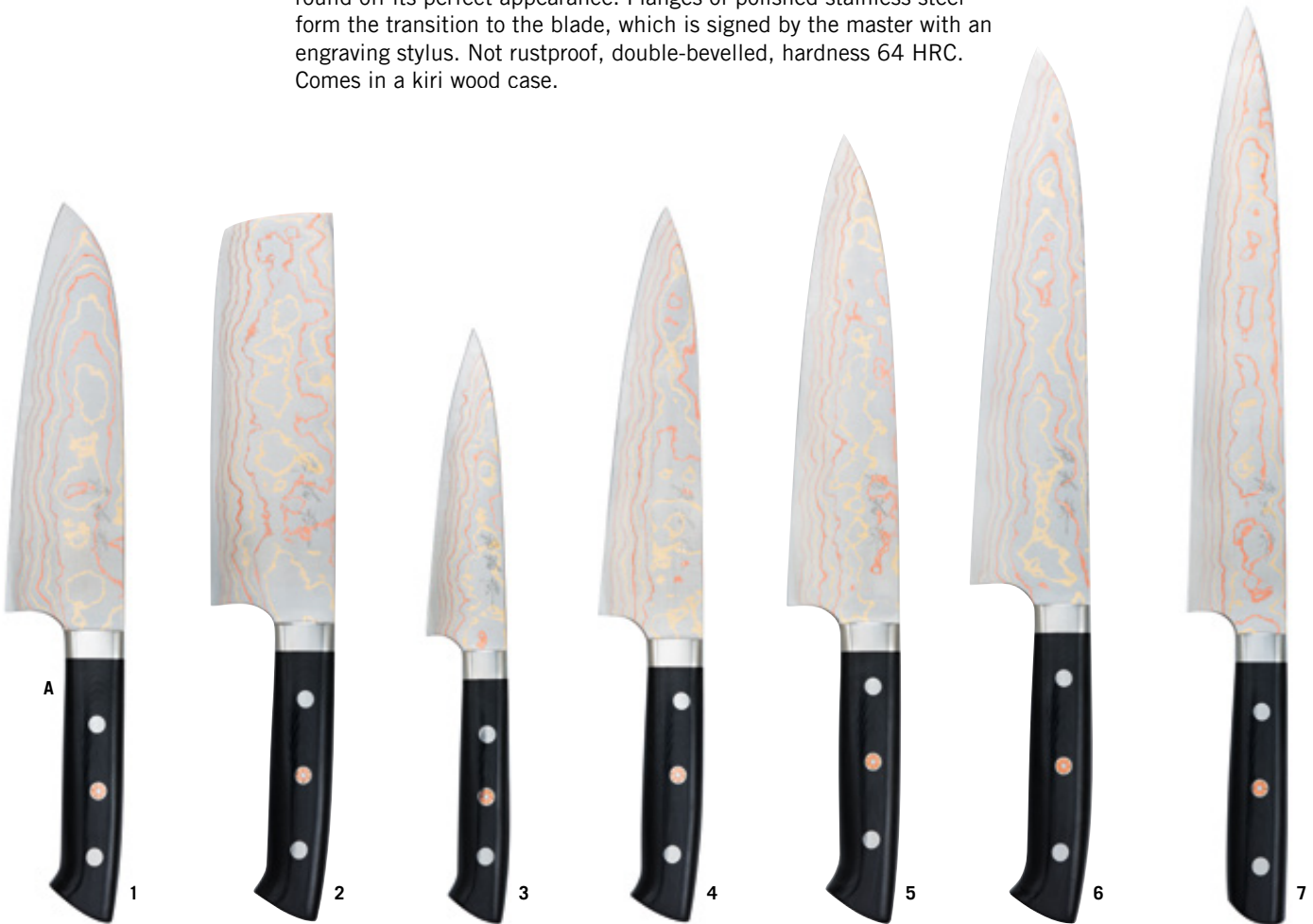

A SAJI RAINBOW HOCHO

1 Santoku, All-purpose Knife
 Blade length 180 mm
 Blade thickness 2 mm
 Overall length 300
 230 g
No. 719960

2 Usuba, Vegetable Knife
 Blade length 170 mm
 Blade thickness 2 mm
 Overall length 300
 260 g
No. 719961

3 Gyuto, Fish and Meat Knife
 Blade length 135 mm
 Blade thickness 2 mm
 Overall length 250
 120 g
No. 719962

4 Gyuto, Fish and Meat Knife
 Blade length 180 mm
 Blade thickness 2.2 mm
 Overall length 300
 200 g
No. 719963

5 Gyuto, Fish and Meat Knife
 Blade length 210 mm
 Blade thickness 2.2 mm
 Overall length 335
 240 g
No. 719964

6 Gyuto, Fish and Meat Knife
 Blade length 240 mm
 Blade thickness 2 mm
 Overall length 375
 290 g
No. 719965

7 Sujihiki, Fish and Meat Knife
 Blade length 270 mm
 Blade thickness 2.3 mm
 Overall length 395
 250 g
No. 719966



8 2-Piece Set *Price advantage*
 • Santoku, all-purpose knife (No. 719960)
 • Gyuto, fish and meat knife (No. 719962)
 • Casket with sliding lid
No. 719967



Inclusive free sharpening pass.
For more information see page 4.



Lifetime sharpening

佐治作



裁前武生



SHIRO KAMO

A SHIRO KAMO HOCHO
The smith Shiro Kamo crafts his blades in the Takefu Knife Village. This is a smithy cooperative that has upheld the tradition of sophisticated metalworking for almost 700 years. The individual Japanese kitchen knives are crafted by hand, using only the best materials. In recognition of his outstanding work, the smith was awarded the title of »Master of the Traditional Craft« at the age of 45. The triple-layered blade has a cutting layer made of Blue Paper Steel and a black forged skin. The octagonal handle made of walnut is completed with a black laminated wooden ferrule. The double-bevelled forged blade carries the smith's signature. Hardness 63 HRC, not rustproof.

1 *Santoku, All-purpose Knife*
Blade length 165 mm
Blade thickness 1.6 mm
Overall length 315 mm
135 g
No. 719882

2 *Bunka, All-purpose Knife*
Blade length 165 mm
Blade thickness 1.8 mm
Overall length 315 mm
140 g
No. 719950

3 *Usuba, Vegetable Knife*
Blade length 165 mm
Blade thickness 1.3 mm
Overall length 310 mm
145 g
No. 719951

4 *Petty, Small All-purpose Knife*
Blade length 90 mm
Blade thickness 1.6 mm
Overall length 215 mm
60 g
No. 719952

5 *Gyuto, Fish and Meat Knife*
Blade length 135 mm
Blade thickness 1.5 mm
Overall length 260 mm
70 g
No. 719953

6 *Gyuto, Fish and Meat Knife*
Blade length 180 mm
Blade thickness 1.5 mm
Overall length 330 mm
140 g
No. 719954

7 *Gyuto, Fish and Meat Knife*
Blade length 215 mm
Blade thickness 1.7 mm
Overall length 365 mm
170 g
No. 719955

**Inclusive free sharpening pass.
For more information see page 4.**



Two free sharpenings

8 *2-Piece Set* **Price advantage**
• Santoku, all-purpose knife (No. 719882)
• Petty, small all-purpose knife (No. 719952)
No. 719956



Octagonal handle
made of walnut wood.

KAMO

The VG-10 steel core is covered by a total of 16 layers of steel, thus creating an interesting Suminagashi pattern. The round sandalwood handle has an interesting red-brown colour and is completed with a black wood laminate ferrule. The blacksmith Shiro Kamo was awarded the title »Master of Traditional Craft« already at the age of 45 years. The rustproof steel blade shows the blacksmith's signature. Hardness 61 HRC, double-bevelled.

**Inclusive free sharpening pass.
For more information see page 4.**



Two free sharpenings



A KAMO HOCHO

1 Santoku, All-purpose Knife
Blade length 155 mm
Blade thickness 2 mm
Overall length 290 mm
120 g
No. 719670

2 Gyuto, Fish and Meat Knife
Blade length 140 mm
Blade thickness 1.4 mm
Overall length 265 mm
75 g
No. 719671

3 Gyuto, Fish and Meat Knife
Blade length 185 mm
Blade thickness 1.9 mm
Overall length 325 mm
135 g
No. 719672

4 Slicer
Blade length 215 mm
Blade thickness 1.5 mm
Overall length 355 mm
110 g
No. 719673

5 Usuba, Vegetable Knife
Blade length 165 mm
Blade thickness 1.8 mm
Overall length 310 mm
170 g
No. 719674

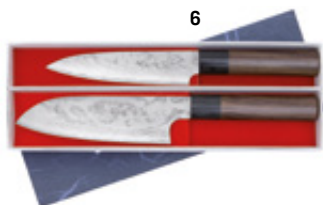

6 2-Piece Set *Price advantage*
• Gyuto, fish and meat knife (No. 719671)
• Santoku, all-purpose knife (No. 719670)
No. 719675



Edged handle made of brown sandalwood, for right-handed use.

越前武生



SHIRO KAMO



The smith Shiro Kamo crafts his blades in the Takefu Knife Village. This is a smithy cooperative that has upheld the tradition of sophisticated metalworking for almost 700 years. The individual Japanese kitchen knives are crafted by hand, using only the best materials. In recognition of his outstanding work, the smith was awarded the title of »Master of Traditional Crafts« at the age of 45. The octagonal handle made of walnut is completed with a laminated wooden ferrule. The forged blade carries the smith's signature. Double-bevelled.



A SHIRO KAMO
HOCHO SANTOKU

1 *White Paper Steel*
In total, the blade consists of 21 layers with a cutting core made of White Paper Steel. Hardness 61 HRC, not rustproof.
Blade length 170 mm
Blade thickness 1.6 mm
Overall length 320 mm
130 g
No. 719881

2 *PM Steel*
Blade with a cutting core made of SG-2 steel produced using powder metallurgy techniques - one of the hardest blade steels worldwide. 30 layers of Suminagashi steel enclose the core cutting layer to create a truly unique structure. Hardness 63 HRC, rustproof.
Blade length 170 mm
Blade thickness 2 mm
Overall length 320 mm
145 g
No. 719883



Octagonal handle made of walnut wood.

龍 蔵



Edged handle made of magnolia wood, for right-handed use.



RYUZO

Traditional Japanese knives with original charm. The forged skin of the triple-layered blade has a distinct hand-hammered surface structure. The traditional Japanese handle is made of magnolia wood and features a finger groove for right-handed use, which makes the knife very comfortable to hold. A buffalo horn ferrule rounds off the handle and joins the triple-layered blade. The cutting layer is made of non-rustproof White Paper Steel. It is perfectly polished, and its high carbon content makes the knife extremely sharp and durable. Blade with signature, double-bevelled. Not rustproof, hardness 63 HRC.

B RYUZO HOCHO

1 Santoku, All-purpose Knife
Blade length 165 mm
Blade thickness 1.8 mm
Overall length 310 mm
135 g
No. 719745

2 Usuba, Vegetable Knife
Blade length 165 mm
Blade thickness 1.8 mm
Overall length 315 mm
160 g
No. 719746

3 Gyuto, Fish and Meat Knife
Blade length 150 mm
Blade thickness 2 mm
Overall length 275 mm
70 g
No. 719748

4 Gyuto, Fish and Meat Knife
Blade length 210 mm
Blade thickness 2.2 mm
Overall length 350 mm
150 g
No. 719747

Inclusive free sharpening pass.
For more information see page 4.



Two free sharpenings



5

5 2-Piece Set *Price advantage*
• Santoku, all-purpose knife
(No. 719745)
• Gyuto, fish and meat knife
(No. 719748)
No. 719749

TADAFUSA »KOBO«



1 Santoku, All-purpose Knife
 Blade length 170 mm
 Blade thickness 1.8 mm
 Overall length 300 mm
 130 g
No. 719660

2 Gyuto, Fish and Meat Knife
 Blade length 120 mm
 Blade thickness 1.6 mm
 Overall length 225 mm
 50 g
No. 719661

**Thermic wood: Under the effect of heat (170-250 °C) and steam, the wood structure is changed and improved for special uses (e.g. in the kitchen) in a targeted and natural way without adding any chemicals. During the special treatment process, the cell wall structure is modified in such a way that the ability to absorb water is reduced and the resistance against bacteria is increased. The thermal treatment also lends the wood a slightly darker tone.*

A TADAFUSA HOCHO, KOBO
 The ancient factory of Tadafusa has been manufacturing high-quality kitchen knives already in the third generation. These hand-forged, triple-layered blades have a core layer made of rust-resistant SLD steel*, and due to its high carbon content it lends the knife an excellent sharpness and impressive edge life. The outer layers are rustproof and thus easy to maintain. The handle is made of heat-treated* chestnut and is comfortable to hold and work with. The stainless steel ferrule creates a smooth transition towards the blade. Hardness 60 HRC, rust-resistant, double-bevelled.

KUMAGORO

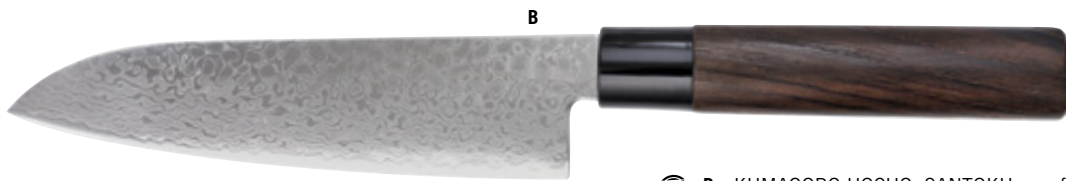

B KUMAGORO HOCHO, SANTOKU
 Japanese all-purpose knife with high-contrast blade for the preparation of vegetables, meat and fish. The core cutting layer is made of ZA-18**, a rustproof steel of the highest grade, which is characterised by its excellent edge life. A total of 72 folded outer layers of stainless steel surround the core cutting layer and create an ornate look. The generously-sized handle made of dark burned chestnut wood is completed with a black plastic ferrule. The wooden

surface is brushed after the burning process, which creates a slightly structured appearance and gives the handle a rustic charm. Rustproof, double-bevelled, hardness 60 HRC.
 **Steel analysis: C = 1.2 / Si = 1 / Mn = 1 / Co = 1.8 / Cr = 18 / Mo = 1.5 / Ni = 0.6 (in %)
 Blade length 185 mm
 Blade thickness 1.3 mm
 Overall length 330 mm
 110 g
No. 719667



C KAMAUSUBA HOCHO
 The Kamausuba is the original vegetable knife design, and its rounded blade shape distinguishes it from the Usuba. This knife is forged by the master Hideo Kitaoka and enables vegetables to be sliced paper-thin. The master smith learned his trade from his father at a young age, and is now famous for his traditional Japanese knives. White Paper Steel is used for the core cutting layer. This

high-purity carbon steel can be ground extremely finely, allowing it to achieve an outstanding level of sharpness. The unique Suminagashi pattern is created from nine folded layers of steel. The octagonal handle is made of magnolia wood and features a buffalo horn ferrule. It also features a traditional Machi - a groove between the blade and the tang. This traditional design originates from Japanese swords, where a hand guard was installed at this

point. Blade with the smith's initials, engraved by hand. Single bevel for right-handed use. Not rustproof, hardness 61 HRC.
 Blade length 170 mm
 Blade thickness 3.2 mm
 Overall length 320 mm
 165 g
No. 719919



SHIGEKI AOGAMI

Japanese kitchen knife with an original look. The traditional Japanese handle made of untreated magnolia is completed with a polymer ferrule; the right-handed, edged handle feels exceptionally comfortable in the hand. The black forging skin was left on the triple-layered blade, making the steel less sensitive to rust while also producing an appealing look. The non-rustproof, soft steel encloses the cutting layer made of hard Blue Paper Steel. The blade is bevelled on both sides, and carries a hand-engraved signature. Hardened to 63 HRC, not rustproof.



Edged handle
made of magnolia
wood, for
right-handed use.

D SHIGEKI AOGAMI HOCHO

1 Santoku, All-purpose Knife
Blade length 165 mm
Blade thickness 1.7 mm
Overall length 310 mm
110 g
No. 719885

2 Usuba, Vegetable Knife
Blade length 165 mm
Blade thickness 1.7 mm
Overall length 305 mm
125 g
No. 719886

3 Gyuto, Fish and Meat Knife
Blade length 185 mm
Blade thickness 2 mm
Overall length 320 mm
125 g
No. 719887

**Inclusive free sharpening pass.
For more information see page 4.**



Two free sharpenings



道場作

KUMAGORO

Classical kitchen knives with finely ground blades, with a non-rustproof Blue Paper Steel cutting edge flanked by two layers of rustproof steel. Together with the black laminated wood handle, this results in a unique Asian appearance. The successful combination of sharpness, lightness and ease of care has made these knives extremely popular in our range for many years. Blade not rustproof, hardness 61 HRC, double-bevelled.



1

A KUMAGORO HOCHO

- 1 3-Piece Set *Price advantage*
- Gyuto, fish and meat knife (No. 719008)
 - Gyuto, fish and meat knife (No. 719003)
 - Usuba, vegetable knife (No.719016)
- No. 719026**



2 *Gyuto, Fish and Meat Knife*
 Blade length 180 mm
 Blade thickness 2 mm
 Overall length 305 mm
 130 g
No. 719003

4 *Usuba, Vegetable Knife*
 Blade length 165 mm
 Blade thickness 2 mm
 Overall length 285 mm
 145 g
No. 719016

3 *Gyuto, Fish and Meat Knife*
 Blade length 135 mm
 Blade thickness 2 mm
 Overall length 250 mm
 95 g
No. 719008

**Inclusive free sharpening pass.
 For more information see page 4.**



Two free sharpenings

忠房作



ARATA

Lovely shaped knives with hand-forged blades of archaic appearance. Cutting edge of Blue Paper Steel flanked by two layers of rustproof steel. Hammered surface, handles of walnut wood. Not rustproof, double-bevelled cutting edge, hardness 63 HRC.

A ARATA HOCHO

1 *Santoku, All-purpose Knife*

Blade length 170 mm
Blade thickness 1.9 mm
Overall length 310 mm
150 g

No. 719148

2 *Petty, Small All-purpose Knife*

Blade length 90 mm
Blade thickness 1.9 mm
Overall length 200 mm
45 g

No. 719370

3 *Gyuto, Fish and Meat Knife*

Blade length 120 mm
Blade thickness 2 mm
Overall length 230 mm
60 g

No. 719371

4 *Gyuto, Fish and Meat Knife*

Blade length 180 mm
Blade thickness 1.8 mm
Overall length 320 mm
135 g

No. 719372

5 *Gyuto, Fish and Meat Knife*

Blade length 210 mm
Blade thickness 2.2 mm
Overall length 350 mm
190 g

No. 719373

6 *Usuba, Vegetable Knife*

Blade length 150 mm
Blade thickness 2.2 mm
Overall length 290 mm
180 g

No. 719147

7 *Sujihiki, Fish and Meat Knife*

Blade length 240 mm
Blade thickness 2 mm
Overall length 380 mm
160 g

No. 719374

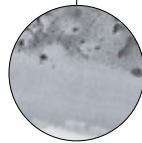
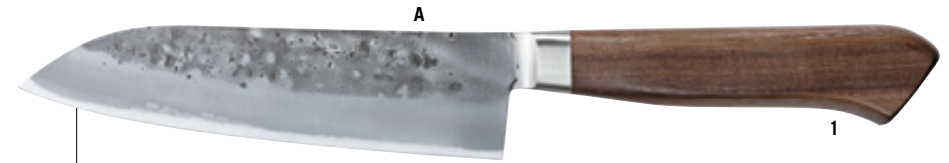

**Inclusive free sharpening pass.
For more information see page 4.**



Two free sharpenings



8

8 *2-Piece Set Price advantage*

- Santoku, all-purpose knife (No. 719148)
- Gyuto, fish and meat knife (No. 719371)

No. 719378



9

9 *3-Piece Set Price advantage*

- Usuba, vegetable knife (No. 719147)
- Santoku, all-purpose knife (No. 719148)
- Gyuto, fish and meat knife (No. 719371)

No. 719375

DICTUM® »KLASSIK«

Classical aesthetics, traditional technology: Perfect, traditional Damascus blades and optimally balanced handles of brown laminated wood. Traditional methods result in classical aesthetics for daily use. 32-layered Suminagashi steel blade with a cutting edge of VG-10 steel. Rustproof. Hardness 62 HRC, double-bevelled.

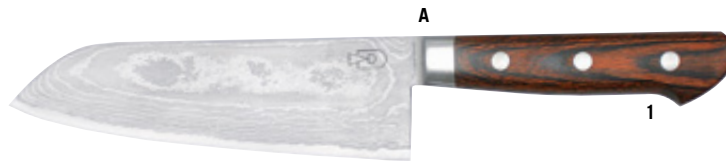

1



2



3



4



5



6



7



8



9



A DICTUM® KNIFE SERIES »KLASSIK«

1 Santoku, All-purpose Knife

Blade length 165 mm
Blade thickness 1.7 mm
Overall length 285 mm
170 g

No. 719296

2 Usuba, Vegetable Knife

Blade length 165 mm
Blade thickness 1.7 mm
Overall length 285 mm
165 g

No. 719297

3 Petty, Small All-purpose Knife

Blade length 80 mm
Blade thickness 1.5 mm
Overall length 185 mm
70 g

No. 719308

4 Gyuto, Fish and Meat Knife

Blade length 120 mm
Blade thickness 1.5 mm
Overall length 220 mm
70 g

No. 719292

5 Gyuto, Fish and Meat Knife

Blade length 150 mm
Blade thickness 1.5 mm
Overall length 260 mm
90 g

No. 719293

6 Gyuto, Fish and Meat Knife

Blade length 180 mm
Blade thickness 1.7 mm
Overall length 295 mm
150 g

No. 719294

7 Gyuto, Fish and Meat Knife

Blade length 210 mm
Blade thickness 2 mm
Overall length 335 mm
200 g

No. 719295

8 Gyuto, Fish and Meat Knife

Blade length 240 mm
Blade thickness 2.2 mm
Overall length 365 mm
260 g

No. 719298

9 Gyuto, Fish and Meat Knife

Blade length 270 mm
Blade thickness 2.2 mm
Overall length 395 mm
270 g

No. 719377

**Inclusive free sharpening pass.
For more information see page 4.**



Two free sharpenings

白刃之森

10



10 5-Piece Set *Price advantage*

- Gyuto, fish and meat knife (No. 719295)
- Usuba, vegetable knife (No. 719297)
- Santoku, all-purpose knife (No. 719296)
- Gyuto, fish and meat knife (No. 719294)
- Gyuto, fish and meat knife (No. 719292)
- Precious knife case made of beechwood (No. 705850)

No. 705883

11



11 2-Piece Set *Price advantage*

- Petty, small all-purpose knife (No. 719308)
- Santoku, all-purpose knife (No. 719296)

No. 719397

DICTUM satisfaction guarantee

Products can be tested for 15 days. (For more information see page 4)



富嶽菜



MATSUNE

A total of 33 layers of steel create a fascinating Suminagashi pattern on the blade, each unique in its structure. The core cutting layer is made of VG-10, a premium quality rustproof steel with an excellent edge life. The ebony-coloured, glue-laminated handle scales made of precious wood are triple-riveted to the angle, the stainless steel ferrule creates a smooth transition towards the blade. Hardness 61 HRC, double-bevelled, rustproof.

A MATSUNE HOCHO

1 Santoku, All-purpose Knife

Blade length 165 mm
Blade thickness 1.8 mm
Overall length 285 mm
170 g

No. 719457

2 Gyuto, Fish and Meat Knife

Blade length 120 mm
Blade thickness 1.5 mm
Overall length 220 mm
70 g

No. 719450

3 Gyuto, Fish and Meat Knife

Blade length 150 mm
Blade thickness 1.6 mm
Overall length 260 mm
90 g

No. 719451

4 Gyuto, Fish and Meat Knife

Blade length 180 mm
Blade thickness 1.8 mm
Overall length 300 mm
160 g

No. 719452

5 Gyuto, Fish and Meat Knife

Blade length 210 mm
Blade thickness 2 mm
Overall length 330 mm
200 g

No. 719453

6 Gyuto, Fish and Meat Knife

Blade length 240 mm
Blade thickness 2.2 mm
Overall length 370 mm
260 g

No. 719454

7 Gyuto, Fish and Meat Knife

Blade length 270 mm
Blade thickness 2.2 mm
Overall length 395 mm
270 g

No. 719455

8 Usuba, Vegetable Knife

Blade length 165 mm
Blade thickness 1.8 mm
Overall length 285 mm
190 g

No. 719458

9 Sujihiki, Fish and Meat Knife

Blade length 240 mm
Blade thickness 2.2 mm
Overall length 360 mm
200 g

No. 719456

10 2-Piece Set **Price advantage**

- Santoku, all-purpose knife (No. 719457)
- Gyuto, fish and meat knife (No. 719451)
- Casket with sliding lid

No. 719459

10



1



2



3



4



5



6



7



8



9

Inclusive free sharpening pass.
For more information see page 4.



Two free sharpenings

養心一刀



Western Design Hocho

The combination of Japanese blade quality and Western kitchen techniques results in high quality cutting utensils. Comfortable in the hand, outstandingly sharp but easy to care for.

SAKAI

Easy to care for Japanese knives in western design. The VG-10 steel cutting core is surrounded by 16 layers of rustproof Suminagashi steel. The hammered structure in the upper section of the blade is not only a visual highlight but also ensures that the material to be cut does not stick so easily to the blade. The handle scales of grained birch plywood are triple-riveted to the tang with stainless steel pins and completed with a stainless steel ferrule. Rustproof, hardness 60 HRC, double bevel.



A SAKAI HOCHO,
BROWN HANDLE
Handle scales made of of grained birch plywood.

1 Santoku, All-purpose Knife
Blade length 185 mm
Blade thickness 1.8 mm
Overall length 305 mm
170 g
No. 708270

2 Usuba, Vegetable Knife
Blade length 165 mm
Blade thickness 1.8 mm
Overall length 290 mm
185 g
No. 708271

3 Petty, Small All-purpose Knife
Blade length 85 mm
Blade thickness 1.7 mm
Overall length 195 mm
75 g
No. 708272

4 Gyuto, Fish and Meat Knife
Blade length 140 mm
Blade thickness 1.8 mm
Overall length 245 mm
90 g
No. 708273

5 Gyuto, Fish and Meat Knife
Blade length 180 mm
Blade thickness 1.8 mm
Overall length 300 mm
150 g
No. 708274

6 Gyuto, Fish and Meat Knife
Blade length 210 mm
Blade thickness 1.8 mm
Overall length 330 mm
180 g
No. 708275

7 Gyuto, Fish and Meat Knife
Blade length 240 mm
Blade thickness 1.8 mm
Overall length 370 mm
250 g
No. 708276

8 Sujihiki, Fish and Meat Knife
Blade length 240 mm
Blade thickness 2 mm
Overall length 370 mm
195 g
No. 708277



9 2-Piece Set *Price advantage*
• Santoku, all-purpose knife (No. 708270)
• Gyuto, fish and meat knife (No. 708273)
No. 708278



10 3-Piece Set *Price advantage*
• Santoku, all-purpose knife (No. 708270)
• Usuba, vegetable knife (No. 708271)
• Gyuto, fish and meat knife (No. 708273)
No. 708279

Inclusive free sharpening pass.
For more information see page 4.

 Two free sharpenings



A SAKAI HOCHO,
BLACK HANDLE
Handle scales made of black
pakka wood.

1 Santoku, All-purpose Knife
Blade length 185 mm
Blade thickness 1.8 mm
Overall length 305 mm
170 g
No. 719970

2 Usuba, Vegetable Knife
Blade length 165 mm
Blade thickness 1.8 mm
Overall length 290 mm
185 g
No. 719971

3 Petty, Small All-purpose Knife
Blade length 85 mm
Blade thickness 1.7 mm
Overall length 195 mm
75 g
No. 719972

4 Gyuto, Fish and Meat Knife
Blade length 140 mm
Blade thickness 1.8 mm
Overall length 245 mm
90 g
No. 719973

5 Gyuto, Fish and Meat Knife
Blade length 210 mm
Blade thickness 1.8 mm
Overall length 330 mm
180 g
No. 719974

6 Gyuto, Fish and Meat Knife
Blade length 240 mm
Blade thickness 2 mm
Overall length 370 mm
255 g
No. 719975

7 Sujihiki, Fish and Meat Knife
Blade length 240 mm
Blade thickness 2 mm
Overall length 370 mm
195 g
No. 719976

Inclusive free sharpening pass.
For more information see page 4.
 Two free sharpenings

8 2-Piece Set *Price advantage*
• Gyuto, fish and meat knife
(No. 719970)
• Santoku, all-purpose knife
(No. 719970)
No. 719977



9 3-Piece Set *Price advantage*
• Santoku, all-purpose knife
(No. 719970)
• Usuba, vegetable knife (No. 719971)
• Gyuto, fish and meat knife
(No. 719973)
No. 719978





名匠並常作

KANETSUNE

Easy-care Japanese kitchen knife in a classic western design. The rustproof triple-layered blade has a cutting core made of VG-10, one of the highest quality rustproof steels characterised by its durable cutting edge. The black laminate wood handle scales are riveted to the tang at three points and completed with a stainless steel ferrule. Rustproof steel blade with signature, hardness 60 HRC, double-bevelled.



B KANETSUNE HOCHO

1 Santoku, All-purpose Knife
Blade length 160 mm
Blade thickness 1.6 mm
Overall length 285 mm
145 g
No. 719795

2 Usuba, Vegetable Knife
Blade length 165 mm
Blade thickness 1.7 mm
Overall length 290 mm
165 g
No. 719796

3 Gyuto, Fish and Meat Knife
Blade length 175 mm
Blade thickness 1.7 mm
Overall length 300 mm
150 g
No. 719797

SHIGEKI
貴
依



SHIGEKI

Puristic classics

The kitchen knives with puristic and simple wood handles impress with their clear shape and pleasantly low weight. High contrast and sharp: Due to the contrast between the Damascus blades and the red birch-wood laminated handles, these knives are a real eye catcher with good price/performance ratio. The 32 layers of Japanese Damascus steel and the cutting edge of VG-10 steel are rustproof. Blade with signature, hardness 61 HRC, double-bevelled.



A SHIGEKI HOCHO

1



- 1 **3-Piece Set** *Price advantage*
- Gyuto, fish and meat knife (No. 719059)
 - Santoku, all-purpose knife (No. 719128)
 - Usuba, vegetable knife (No. 719129)
 - Wooden case (No. 705885)
- No. 719233**

2



- 2 **3-Piece Set** *Price advantage*
- Gyuto, fish and meat knife (No. 719771)
 - Santoku, all-purpose knife (No. 719770)
 - Usuba, vegetable knife (No. 719773)
 - Wooden case (No. 705885)
- No. 719774**

Inclusive free sharpening pass.
For more information see page 4.



Two free sharpenings



B SHIGEKI HOCHO
Red birch wood laminated handles.

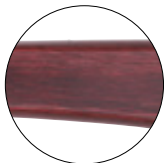

1 Santoku, All-purpose Knife
Blade length 165 mm
Blade thickness 1.8 mm
Overall length 290 mm
140 g
No. 719128

2 Petty, Small All-purpose Knife
Blade length 115 mm
Blade thickness 1.5 mm
Overall length 230 mm
75 g
No. 719788

3 Gyuto, Fish and Meat Knife
Blade length 155 mm
Blade thickness 1.8 mm
Overall length 270 mm
90 g
No. 719059

4 Gyuto, Fish and Meat Knife
Blade length 185 mm
Blade thickness 1.8 mm
Overall length 310 mm
130 g
No. 719775

5 Usuba, Vegetable Knife
Blade length 165 mm
Blade thickness 1.5 mm
Overall length 290 mm
150 g
No. 719129

6 Mincing knife
Blade length 90 mm
Blade thickness 2 mm
Overall length 225 mm
90 g
No. 719716

7 2-Piece Set, Santoku and Gyuto
Price advantage

- Santoku, all-purpose knife (No. 719128)
- Gyuto, fish and meat knife (No. 719059)

No. 719778



8 2-Piece Set, Usuba and Gyuto
Price advantage

- Usuba, vegetable knife (No. 719129)
- Gyuto, fish and meat knife (No. 719059)

No. 719779



C SHIGEKI HOCHO KURO
Black birch wood laminated handles.



1 Santoku, All-purpose Knife
Blade length 165 mm
Blade thickness 1.8 mm
Overall length 290 mm
140 g
No. 719770

2 Petty, Small All-purpose Knife
Blade length 115 mm
Blade thickness 1.5 mm
Overall length 230 mm
75 g
No. 719789

3 Gyuto, Fish and Meat Knife
Blade length 155 mm
Blade thickness 1.8 mm
Overall length 270 mm
90 g
No. 719771

4 Gyuto, Fish and Meat Knife
Blade length 185 mm
Blade thickness 1.8 mm
Overall length 310 mm
130 g
No. 719772

5 Usuba, Vegetable Knife
Blade length 165 mm
Blade thickness 1.5 mm
Overall length 290 mm
150 g
No. 719773

6 Mincing knife
Blade length 90 mm
Blade thickness 2 mm
Overall length 225 mm
90 g
No. 719717

7 2-Piece Set, Santoku and Gyuto
Price advantage

- Santoku, all-purpose knife (No. 719770)
- Gyuto, fish and meat knife (No. 719771)

No. 719776



8 2-Piece Set, Usuba and Gyuto
Price advantage

- Usuba, vegetable knife (No. 719773)
- Gyuto, fish and meat knife (No. 719771)

No. 719777



MINA

An accomplished, easy-care combination of a rustproof Suminagashi blade with rugged handle scales made of brown wooden laminate. The central cutting layer made of rustproof VG-10 steel is enclosed within 16 layers of Suminagashi steel, which also creates an attractive look. Double bevel, rustproof, hardened to 60 HRC.



A MINA HOCHO

1 *Santoku, All-purpose Knife*

Blade length 170 mm
Blade thickness 1.8 mm
Overall length 305 mm
200 g
No. 719870

2 *Bunka, All-purpose Knife*

Blade length 175 mm
Blade thickness 1.8 mm
Overall length 305 mm
200 g
No. 719871

3 *Usuba, Vegetable Knife*

Blade length 175 mm
Blade thickness 1.9 mm
Overall length 310 mm
220 g
No. 719872

4 *Petty, Small All-purpose Knife*

Blade length 95 mm
Blade thickness 1.9 mm
Overall length 205 mm
100 g
No. 719873

5 *Gyuto, Fish and Meat Knife*

Blade length 125 mm
Blade thickness 1.8 mm
Overall length 240 mm
115 g
No. 719874

6 *Gyuto, Fish and Meat Knife*

Blade length 155 mm
Blade thickness 1.8 mm
Overall length 270 mm
130 g
No. 719875

7 *Gyuto, Fish and Meat Knife*

Blade length 185 mm
Blade thickness 1.7 mm
Overall length 320 mm
210 g
No. 719876

8 *Gyuto, Fish and Meat Knife*

Blade length 220 mm
Blade thickness 1.8 mm
Overall length 360 mm
250 g
No. 719877

9 *Yanagiba, Fish Knife*

Blade length 270 mm
Blade thickness 2.7 mm
Overall length 420 mm
250 g
No. 719878

吉田

10



10 5-Piece Set *Price advantage*

Set includes:

- Bunka, all-purpose knife (No. 719871)
- Usuba, vegetable knife (No. 719872)
- Gyuto, fish and meat knife (No. 719874)
- Gyuto, fish and meat knife (No. 719875)
- Gyuto, fish and meat knife (No. 719877)
- Precious knife case made of beechwood (No. 705850)

No. 719866

11



11 2-Piece Set *Price advantage*

- Santoku, all-purpose knife (No. 719870)
- Petty, small all-purpose knife (No. 719873)

No. 719865

Inclusive free sharpening pass.
For more information see page 4.



Two free sharpenings



半月



A ECLIPSE HOCHO

The combination of rustproof mono-steel blade and handle scales made from Corian® makes this knife an easy to care for tool and guarantees a high standard of hygiene. The Corian® composite material is pore-free and thus easy to clean, robust and very durable, with a marble-like appearance. Stainless

steel pins and ferrules. The rustproof mono-steel blade made of AUS8* steel from Aichi is extremely easy to sharpen and highly wear-resistant. Hardened to 59 HRC, double bevel.

* Steel analysis: C = 0.7 / Cr = 14 / Mo = 0.2 / V = 0.2 (in %)

1 Santoku, All-purpose Knife

Blade length 175 mm
Blade thickness 2 mm
Overall length 300 mm
190 g
No. 718405

2 Gyuto, Fish and Meat Knife

Blade length 210 mm
Blade thickness 2 mm
Overall length 330 mm
190 g
No. 718406

BRIETO®

When it comes to professional culinary knives, the Japanese Brieto knives are in a class of their own. Their seamless construction makes them **extremely hygienic** and **easy to care for**, also suitable for gastronomy. The ergonomically designed handles can be **held comfortably** and **securely** even when wet due to their brushed, hammered surface. Brieto knives are astonishingly light and therefore reduce wrist and hand fatigue when undertaking repetitive cutting. The knife's stainless steel handle instantly takes on **body temperature** and feels like the natural extension of your hand. The blade is made of rustproof AUS-6M Mono Steel*. The cryogenic hardening process applied to these knives makes the steel exceptionally fine-grained, resulting in an extremely sharp and durable blade. Handle made of stainless steel 18/8**, hardness 58 HRC, double-bevelled.

* Steel analysis: C = 0.6 / Cr = 14 /
Mo = 0.2 / V = 0.2 (in %)

** Steel analysis: Cr = 18 / Ni = 8 (in %)

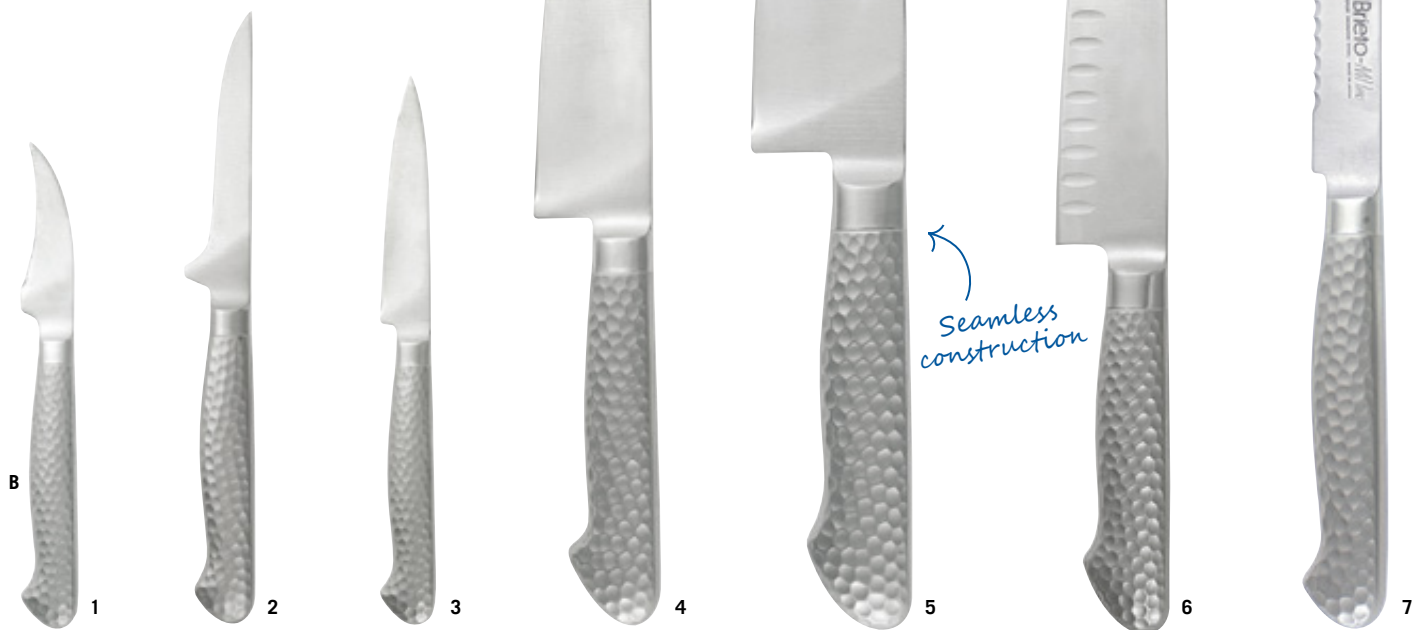

B BRIETO®

 **1 Peeling Knife**
This knife features a curved blade.
Blade length 70 mm
Blade thickness 2.1 mm
Overall length 180 mm
45 g
No. 719156

 **2 Boning Knife**
Flexible blade with hand guard.
Blade length 100 mm
Blade thickness 1.8 mm
Overall length 225 mm
60 g
No. 719155

 **3 All-purpose Knife**
Thin, semi-flexible blade.
Blade length 100 mm
Blade thickness 1.9 mm
Overall length 210 mm
50 g
No. 719154

 **4 Cooking Knife, 160 mm**
Blade length 160 mm
Blade thickness 2 mm
Overall length 295 mm
135 g
No. 719152

 **6 Filleting Knife**
Semi-flexible, narrow blade with non-stick corrugated sides, minimal cutting resistance, for fish, meat, and ham. The alternating hollows on the blade's sides ensure minimal friction and prevent the food from clinging.
Blade length 300 mm
Blade thickness 2 mm
Overall length 435 mm
205 g
No. 719159

 **5 Cooking Knife, 200 mm**
Blade length 200 mm
Blade thickness 2.2 mm
Overall length 340 mm
195 g
No. 719153

7 Salami and Baguette Knife
Ideal knife for thin slices, it fits comfortably, slip-proof and lightweight in your hand. The flexible Japanese blade with serrated edge is also ideal for small pieces of ham.
Blade length 160 mm
Blade thickness 1.9 mm
Overall length 280 mm
70 g
No. 719158

Inclusive free sharpening pass.
For more information see page 4.

 Two free sharpenings



SAKU

These all-purpose blades are exactly right for becoming acquainted with traditional Japanese knives: The sharp cutting edge made of carbon steel is flanked by two layers of stainless steel, which makes it easier to care for. The oval-shaped chestnut wood handle is completed with a black ferrule. These knives are available with or without wooden sheath. Hardness 60 HRC, not rustproof, double bevel.



A SAKU HOCHO, WITH WOODEN SHEATH

1 Santoku, All-purpose Knife
Blade length 135 mm
Blade thickness 1.7 mm
Overall length 255 mm
70 g
No. 719723

2 Gyuto, Fish and Meat Knife
Blade length 140 mm
Blade thickness 1.7 mm
Overall length 260 mm
65 g
No. 719724

3 Usuba, Vegetable Knife
Blade length 130 mm
Blade thickness 1.8 mm
Overall length 250 mm
75 g
No. 719725

4 Petty, Small All-purpose Knife
Blade length 90 mm
Blade thickness 1.3 mm
Overall length 205 mm
35 g
No. 719719

Oval-shaped chestnut wood handle.

S SAKU HOCHO, WITHOUT WOODEN SHEATH

Santoku, All-purpose Knife
Blade length 135 mm
Blade thickness 1.7 mm
Overall length 255 mm
70 g
No. 719720

Gyuto, Fish and Meat Knife
Blade length 140 mm
Blade thickness 1.7 mm
Overall length 260 mm
65 g
No. 719721

Usuba, Vegetable Knife
Blade length 130 mm
Blade thickness 1.8 mm
Overall length 250 mm
75 g
No. 719722

Petty, Small All-purpose Knife
Blade length 90 mm
Blade thickness 1.3 mm
Overall length 205 mm
35 g
No. 719718

5 3-Piece Set in Roll Pouch
Saku Hocho 3-piece knife set with dark brown leather roll pouch. Great for storage or as a gift.
• Usuba, vegetable knife (No. 719725)
• Gyuto, fish and meat knife (No. 719724)
• Santoku, all-purpose knife (No. 719723)

No. 719726

B JAPANESE KNIFE SET WITH COMBINATION SHARPENING STONE AND SHARPENING DVD

Price advantage

Celebrate the art of cutting with our versatile Japanese knives:

A Gyuto for fish and meat, the Usuba for cutting vegetables into wafer-thin slices and for peeling. In order to help you keep these valuable pieces razor-sharp, a combination sharpening stone is included, along with an instructional DVD. The set comes in a beautiful wood case, ideal for storage or as a gift.

Set includes:

- Gyuto, fish and meat knife (No. 719721)
- Usuba, vegetable knife (No. 719722)

- Combination Stone 1000/6000 (No. 711007)
 - Sharpening DVD (in German) (No. 713806)
 - Wooden Case (No. 820239)
- No. 719728**



C SAKU HOCHO SANTOKU WITH TOKICO® KNIFE SHARPENER

Price advantage

- Santoku, all-purpose knife (No. 719720)
- Tokico Knife Sharpener (No. 705373)

Blade length 135 mm
Blade thickness 1.7 mm
Overall length 255 mm
70 g
No. 719727



► For a starter set - Japanese knife and combination stone with Sharpening Primer (No. 711085) - see www.dictum.com

SMALL KNIVES

Light-duty knives with rustproof, triple-layered blades and sheaths made of water-resistant enju wood. Double-bevelled. Hardness 58 HRC.



Oval-shaped enju wood handle.

D SMALL KNIFE WITH SHEATH

1 All-purpose Knife
Blade length 105 mm
Blade thickness 1.2 mm
Overall length 220 mm
40 g
No. 719217

2 Fruit Knife
Blade length 100 mm
Blade thickness 1.2 mm
Overall length 200 mm
30 g
No. 719020

3 Vegetable Knife
Blade length 105 mm
Blade thickness 1.2 mm
Overall length 220 mm
40 g
No. 719229



4 3-Piece Set
With this starter kit you are well prepared for any cutting work. Three compact knives in an attractive red leather roll-up case:

- Vegetable knife (No. 719229)
- Fruit knife (No. 719020)
- All-purpose knife (No. 719217)

No. 719195

Inclusive free sharpening pass.
For more information see page 4.

 Two free sharpenings

► For a snack set with fruit knife and wooden board (No. 707935) see page 108.



美貴久

MIKIHISA

Double-layered blade with cutting layer made of Takefu White Paper Steel, black forged skin and hammered surface structure. Handle made of untreated magnolia wood with black ferrule. Single bevel for right-handed use. Hardness HRC 62, not rustproof.



 **A MIKIHISA HOCHO,**
2-PIECE SET *Price advantage*

- Ajikiri (No. 719783): the wide blade is ideal for preparing small fish, cleaning vegetables and salad, as well as chopping and rocking herbs.
- Petty (No. 719786): ideal for all types of small cutting tasks in the kitchen.

No. 719787

B MIKIHISA HOCHO, AJIKIRI

The wide blade of the Ajikiri is ideal for preparing small fish, cleaning vegetables and salad, as well as chopping and rocking herbs. Double-layered blade with cutting layer made of Takefu White Paper Steel, black forged skin and hammered surface structure. Handle made of untreated magnolia wood with black ferrule. Single bevel for right-handed use. Hardness HRC 62, not rustproof.

1 75 mm

Blade length 75 mm
Blade thickness 2.6 mm
Overall length 190 mm
65 g

No. 719780**2** 90 mm

Blade length 90 mm
Blade thickness 2.6 mm
Overall length 200 mm
75 g

No. 719781**3** 105 mm

Klingenlänge 105 mm
Klingenstärke 2.6 mm
Gesamtlänge 230 mm
90 g

No. 719782**4** 120 mm

Blade length 120 mm
Blade thickness 2.6 mm
Overall length 240 mm
100 g

No. 719783

Inclusive free sharpening pass.
For more information see page 4.



Two free sharpenings

Edged handle made
of magnolia wood, for
right-handed use.

**C** MIKIHISA HOCHO, PETTY

Ideal for all types of small cutting tasks in the kitchen. Double-layered blade with cutting layer made of Takefu White Paper Steel, black forged skin and hammered surface structure. Handle made of untreated magnolia wood with black ferrule. Single bevel for right-handed use. Hardness HRC 62, not rustproof.

1 90 mm

Blade length 90 mm
Blade thickness 2.6 mm
Overall length 205 mm
65 g

No. 719023**2** 105 mm

Blade length 105 mm
Blade thickness 2.6 mm
Overall length 225 mm
70 g

No. 719784**3** 120 mm

Blade length 120 mm
Blade thickness 2.6 mm
Overall length 240 mm
80 g

No. 719785**4** 150 mm

Blade length 150 mm
Blade thickness 2.6 mm
Overall length 270 mm
95 g

No. 719786

12 IMPORTANT TIPS ON HANDLING AND CARE

How do I choose the right knife, how do I care for and store it?

Below we highlight some of the most important issues regarding Japanese knives - if you have any further questions, feel free to contact our customer service at any time via mail or telephone:
Tel. + 49 (0) 9931 4058-912, info@dictum.com

1 WHICH KIND OF CHOPPING BOARD SHOULD I USE?

The correct cutting board - and this applies to all knives, not just original Japanese ones - is made of wood or plastic.

Working on hard underlays, such as porcelain, marble or glass quickly dulls the blade. In our online shop we offer a number of chopping boards made of e.g. acacia or ginkgo. www.dictum.com



2 HOW DO I CLEAN RUSTPROOF AND NON-RUSTPROOF KNIVES?

Clean the knife by hand, rinsing it under lukewarm water and, if required, adding a little washing-up liquid, and dry it afterwards. Do not use scouring powder and never put the knife in the dishwasher, even if it is rustproof.

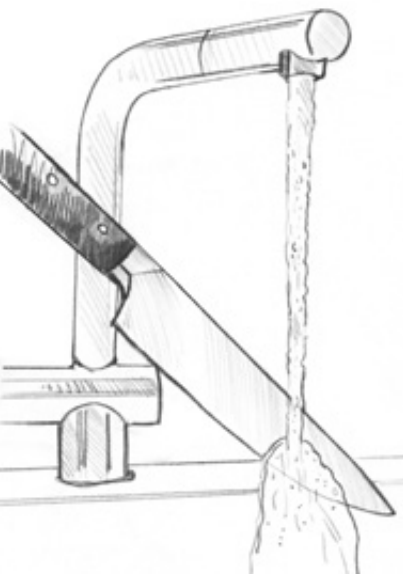

3 WHICH BASIC EQUIPMENT IS RECOMMENDED?

As a start, we recommend a Santoku (all-purpose knife) plus a Petty (fruit and peeling knife) or a Gyuto (fish and meat knife) up to 150 mm blade length. Extend your equipment following the intended use and your personal preferences.



4 WHICH KNIFE IS THE RIGHT ONE?

The right choice of knife depends on the intended use, how much time one is willing to invest in knife care and - last but not least - personal preferences. Come and test a wide range of knives in our shops in Munich and Plattling, we will be happy to advise you. (For further information on our shops and opening hours see page 215.)



5 HOW CAN I PROTECT MY NON-RUSTPROOF KNIFE FROM OXIDATION?

Non-rustproof knives can be oiled with camellia oil to protect them from rust, if necessary. Knives must never be left or stored moist or wet. The sooner the knife is cleaned after use, the better it is preserved. This is particularly true when you have cut acidic food like lemons.

Tip:

You can also oil the wooden knife handle, if necessary.

6

HOW DO I STORE THE KNIFE?

Prevent the cutting edge from coming into contact with other knives, metals or crockery. Store your knife separately in a knife block, a knife rack or a wooden box. Or follow the example of Japanese cooks who wrap their knives in cloths. A selection of knife blocks can be found in our online shop www.dictum.com



7

WHICH ARE THE ADVANTAGES OF SINGLE-BEVELLED BLADES?

This kind of knife features a hollow grind on the flat side of the blade, which creates a kind of air cushion between the blade and the material being cut. The alternating hollows ensure minimal friction and allow for precise filleting and more accurate cuts. For this reason, most fish knives are single-bevelled.



8

WHICH KNIVES ARE SUITED FOR RIGHT- AND LEFT-HANDED USE?

In general, knives with a double bevel are suited for right- and left-handed use. An edged handle for right-handed use may be uncomfortable for left-handed use.

9

CAN I CUT BONES WITH MY KNIFE?

No, a knife is not suitable for cutting hard food.

Avoid exposing the blade to breaking, bending and impact stress. Rough handling can cause the blades to break.

Tip:

The **blade back** of a Deba is suitable for cutting thin bones.

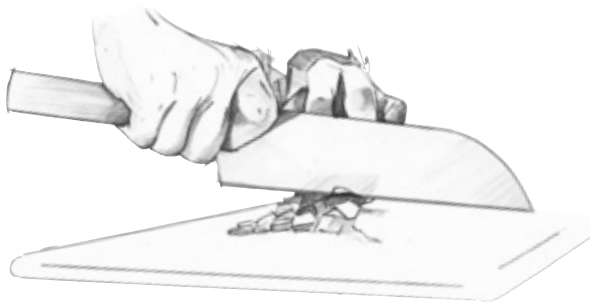

11

WHAT CUTTING TECHNIQUE SHOULD I USE?

Let the knife glide through the food without exerting much pressure. Use the entire length of the blade and make straight, pulling cuts. Cut soft food like ripe fruit, vegetables, fish and tender meat with a pulling cut whenever possible. The longer the cutting line, the lower the cutting resistance.

Tip: Be kind to your blade and do not push the cut food from the chopping board with the cutting edge - use the back of the blade.

10

HOW CAN I KEEP MY KNIFE SHARP?

A) Sharpening courses: Get a perfect introduction to the art of knife sharpening by visiting one of our one-day sharpening courses held by sharpening experts.

B) Instruction video: Watch our helpful instruction video on sharpening Japanese knives (No. 713806).

C) Sharpening Primer: Take advantage of our tips and tricks on knife sharpening in our free Sharpening Primer. You can order it free of charge at www.dictum.com

D) Sharpening service: You can also send us your knife and take advantage of our Sharpening Service - more information can be found on page 213.



12

WHICH SPECIAL KNIVES DO I NEED IN THE KITCHEN?

Japanese knives should not be used for anything else other than cutting, trimming and peeling, so you will need a mincing knife for chopping herbs. You will also need a sharp peeler. Please find an extensive range of

kitchen utensils, such as cast iron frying pans, graters and tea bowls in our online shop www.dictum.com





A

A JAPANESE MINCING KNIFE
 This knife is forged exclusively for our customers by our Japanese master. Fitted with a heavy, arched blade it chops all types of herbs with a rocking cut. Tender stems and leaves are not squashed but cut to enhance the flavour. Triple-layered steel blade*, ground razor-sharp, surface left in forged condition with burned-in linseed oil (antirust). Every knife is signed by the master. Mag-

nolia wood handle with a buffalo horn ferrule, double bevel.

* Core layer of Blue Paper Steel, 61 HRC, iron outer layers (not rustproof).

Blade length 135 mm
 Blade thickness 6 mm
 Overall length 270 mm
 280 g

No. 719253



B

B CHINESE COOKING KNIFE
 From traditional Chinese cuisine: This cleaver from a traditional Shanghai manufacturer features a high-quality, triple-layered steel blade offering superior sharpness and edge life. The blade, ferrule and tang are forged from a single piece of steel, the colourfully accent-

ed pakka wood handle is seamlessly attached. Rustproof, double-bevelled, hardness 56 HRC.

Blade length 185 mm
 Blade thickness 2.8 mm
 Overall length 310 mm
 430 g

No. 708082



1



2

C JAPANESE KITCHEN FOLDING KNIVES »ONO«

This practical knife is useful for cooking away from home. Whether sailing or camping, this folding knife can be stored in a minimum of space and is well protected when you are out and about. Easy to maintain and a great head-turner: 32 layers of Japanese Damascus steel surround the cutting edge of VG-10 steel. The blade is safely held in place via a back-lock mechanism. Handle scales of laminated precious wood with red fibre. The blade is fully rustproof, double-bevelled, hardness 61 HRC.

1 Santoku, All-purpose Knife

Blade length 100 mm
 Blade thickness 3 mm
 Overall length 250 mm
 220 g

No. 719286

2 Usuba, Vegetable Knife

Blade length 100 mm
 Blade thickness 3 mm
 Overall length 255 mm
 225 g

No. 719287

Inclusive free sharpening pass. For more information see page 4.



Two free sharpenings



D MASERIN® ROCKER KNIFE
The handy rocker chopper features two ergonomic beechwood handles. It is ideal for cutting herbs, onions, seasoning and other cooking ingredients.

The curved blade is made of 420 steel with a hardness of 56 HRC.
Blade length 200 mm
205 g
No. 709509



E KITCHEN KNIVES, 4-PIECE SET
Practical 4-Piece Set of kitchen knives with olive wood handles. Ideal for all small tasks in the kitchen or for picnics. The blades are made of rustproof steel.

Set contains:
• All-purpose knife
• Fruit knife or peeling knife
• Double-blade peeler
• Serrated vegetable knife
No. 719376

F SMALL JAPANESE ALL-PURPOSE KNIFE »MIKI«
Ideal for peeling and cleaning fruit and vegetables and all types of small cutting tasks in the kitchen. It consists of a VG-10 steel cutting edge and stainless steel outer layers. Laminated birch wood

handle. Double-bevelled, rustproof, hardness 61 HRC.
Blade length 80 mm
Blade thickness 1.5 mm
Overall length 190 mm
60 g
No. 719304



G LIONSTEEL® ALL-PURPOSE KNIFE
Simply constructed all-purpose knife with olive wood handle. Ideal for all smaller tasks in the kitchen or also suitable to be used as a steak knife. The blade is made of rustproof 1.4116 steel. Hardness 56 HRC.

1 All-purpose Knife
Blade length 100 mm
Blade thickness 2.1 mm
Overall length 210 mm
55 g
No. 709325

2 4-Piece Set
Comes in a stylish wood casket and makes an excellent gift.
Blade length 100 mm
Blade thickness 2.1 mm
Overall length 210 mm
55 g
No. 709326



H LE THIERS® CHEESE KNIVES, 2-PIECE SET

Two-piece cheese knife set comprising
• Cheese knife with fork tip for cutting soft and semi-hard cheese.
• Cheese cleaver, ideal for hard cheese.

Handle scales made of olive wood with a honey-coloured grain. The wood has excellent material properties and has been appreciated for centuries because of its warm colour. The mirror-polished

blades, bevelled on both sides, are made from rustproof X50CrMoV15 steel, hardened to 55 HRC. Supplied in lockable beechwood box.
Overall length 240 mm
No. 719989

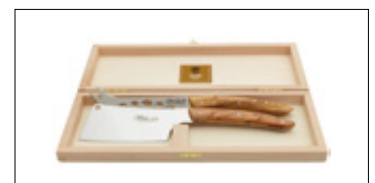

I LARGE CHEESE KNIFE
Innovative cheese knife from France. Thanks to the plate on the underside of the handle tip, the knife sits on the table without the blade touching it. Handle scales made of resistant masur birch. With black liner material between the plate and the handle scales. The mirror-polished blade, bevelled on both sides, is made from rustproof X50CrMoV15 steel, hardened to 55 HRC.

Blade length 135 mm
Blade thickness 2 mm
Overall length 270 mm
120 g
No. 719988

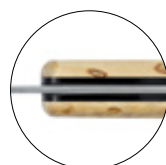

JAPANESE STEAK AND TABLE KNIVES



A STEAK KNIFE VG-10, MICARTA
 This elegant steak knife is a head-turner on any set table. The vividly patterned blade is created by a total of 34 folded, rustproof outer layers. The cutting layer is made of VG-10, a rustproof steel of the highest grade, which is characterised by its excellent edge life. The handle scales made of black paper micarta are triple riveted to the tang with stainless steel pins and completed with polished stainless steel bolsters. The blade is rustproof, double-bevelled and has a hardness of 59 HRC.
 Blade length 120 mm
 Blade thickness 1.6 mm
 Overall length 225 mm
 70 g
No. 719699



B STEAK KNIFE
 From the Japanese Hiroaki Masui blacksmith workshop. A total of 32 layers form this impressive Suminagashi pattern around the core layer made of edge-holding VG-10 steel. The perfectly sized handle with its soft structure is made of dark brown Pao Rosa wood and is very comfortable to hold. The handle features a vulcanized fibre insert and a rosette-shaped mosaic pin. The rustproof blade is double-bevelled and has a high-gloss finish. Hardness 58 HRC.
 Blade length 120 mm
 Blade thickness 1.6 mm
 Overall length 250 mm
 60 g
No. 719696



C YOSEGI ICHIMATSU STEAK KNIFE
 The traditional Japanese art of woodwork «Hakone Yosegi Zaiku» is reflected in this elaborately crafted handle. Walnut and Mizuki (pagoda dogwood) are artistically combined to create this attractive pattern. The Hitachi ATS314 steel* core layer is sandwiched between a total of 62 folded stainless steel outer layers, creating a fascinating blade pattern. Double bevel, rustproof, hardness 60 HRC.

* Steel analysis: C = 1 / Si = 0.3 / Mn = 0.4 / P < 0.03 / S = 0.004 / Co = 1.4 / Cr = 15 / Mo = 1 / V = 0.2 / Ni = 0.15 (in %)

Blade length 100 mm
 Blade thickness 1.5 mm
 Overall length 220 mm
 50 g
No. 725001

Inclusive free sharpening pass.
 For more information see page 4.

Two free sharpenings



D JAPANESE CUTLERY
 Elegant design and outstanding sharpness distinguish this Japanese steak knife. The design of the elegant ebony handle scales ensures that the blade does not rest on the table. A special feature is that the blade has no core cutting layer. Ryusen uses a forging technique that has been passed down from generation to generation for decades. In total, a composite of 70 layers of VG10 and VG2 steel is processed to create the unique Damascus pattern. Additional polishing of the blade makes the individual layers even more striking. The knife is available on its own or as a set with matching fork. Single bevel for right-handed use. Rustproof, hardness 60 HRC.



1 Steak and Table Knife
 Blade length 115 mm
 Blade thickness 1.6 mm
 Overall length 225 mm
 55 g
No. 725006

2 Steak and Table Knife with Fork
No. 725008

LE THIERS® TABLE KNIVES



E LE THIERS® SHADOW TABLE KNIVES, 6-PIECE SET

These exclusive table knives were created in cooperation with Thomas Bastide, a French designer. The asymmetrical design of both handle scales, whereby the right handle scale is significantly thicker and sloped at a 15° angle, ensures an excellent grip. At the same time, the chosen angle allows it to stand in place without the blade touching the table. The handle scales are made of a combination of black and cream-coloured plastic and fastened to the tang with three rivets. The double-bevelled blade of rustproof X50CrMoV15 steel* is mirror-polished and has a hardness of 56 HRC.

* Steel analysis: C = 0.5 / Cr = 15 / Mo = 1 / V = 1 (in %)

Blade length 110 mm
Blade thickness 2 mm
Overall length 230 mm
75 g
No. 709682



LE THIERS® STEAK KNIVES



F LE THIERS® STEAK KNIVES, 6-PIECE SET

With their special teeth, these knives will take all the effort out of cutting your steak or grilled food. The mirror finish on the blade, handle tang and handle end give the steak knives an elegant and timeless look. Made from a single piece of steel, they have no joints and thus meet the highest standards of hygiene in everyday use. The knives are rustproof and easy-care.

Blade length 110 mm
Blade thickness 1.5 mm
Overall length 230 mm
80 g
No. 719337



FRENCH STEAK AND TABLE KNIVES



A LE THIERS® STEAK AND TABLE KNIVES

Thanks to their low weight, these elegantly designed knives fit comfortably in the hand. The double bevel edge made of rustproof X50CrMoV15 steel* is polished to a mirror finish and achieves a hardness of 56 HRC. Comes in a locking case made of beech wood.

* Steel analysis: C = 0.5 / Cr = 15 / Mo = 1 / V = 1 (in %)

Blade length 110 mm
Overall length 230 mm
70 g

1 Olive Wood

Handle scales made of olive wood with honey-coloured grain. The wood has excellent properties and has therefore been regarded as a valuable material for many centuries due to its warm colouring. Blade thickness 2 mm

2-Piece Set **No. 719990**
4-Piece Set **No. 719991**

2 Masur Birch

Handle scales made of robust masur birch wood. Black liner material between the plates and handle scales. Blade thickness 2.4 mm

2-Piece Set **No. 719998**
4-Piece Set **No. 719999**

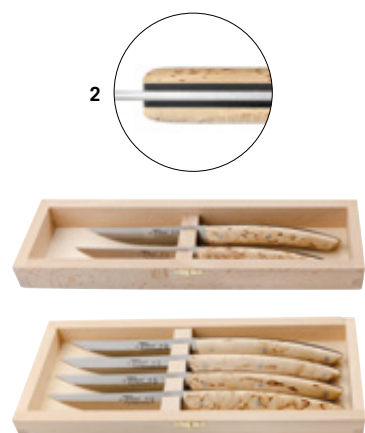

B LE THIERS® ART DECO STEAK AND TABLE KNIVES

Elegant steak and table knives with handle scales made of black ebony, one of the densest and hardest types of wood in the world. Polished stainless steel ferrules provide the transition to the blade and create an excellent visual effect. The double bevel edge made of rustproof X50CrMoV15 steel* is polished to a mirror finish and achieves a hardness of 56 HRC. Blade length 110 mm

Blade thickness 2 mm
Overall length 230 mm
100 g

* Steel analysis: C = 0.5 / Cr = 15 / Mo = 1 / V = 1 (in %)

1 2-Piece Set
Comes in a locking case made of beech wood.
No. 719992

2 4-Piece Set
Comes in a locking case made of oak.
No. 719993



Inclusive free sharpening pass.
For more information see page 4.

 Two free sharpenings



C LAGUIOLE STEAK AND TABLE KNIVES

These beautifully shaped knives are an eye-catcher on any laid table. Thanks to their slightly curved handle, they are comfortable to hold. The handle spine is adorned with decoration filed by hand and the Laguiole trademark - the bee. Mirror-polished blade made of rustproof X50CrMoV15 steel*. Comes in a lockable case made of beech wood. Double bevel, rustproof, hardness 56 HRC.

* Steel analysis: C = 0.5 / Cr = 15 / Mo = 1 / V = 1 (in %)

Blade length 105 mm
Overall length 230 mm

1 Juniper
Grained juniper wood handle scales with stainless steel bolsters.
Blade thickness 1.9 mm
85 g

2-Piece Set **No. 719994**
4-Piece Set **No. 719995**

2 Ebony
Handle scales made of elegant black ebony, one of the densest and hardest woods in the world, stainless steel bolsters.
Blade thickness 2 mm
90 g

2-Piece Set **No. 719996**
4-Piece Set **No. 719997**

3 Staghorn
Slightly textured handle scales made of staghorn.
Blade thickness 1.9 mm
110 g

2-Piece Set **No. 719986**
4-Piece Set **No. 719987**

► For cutting boards, knife blocks and kitchen utensils see our »Tool Catalogue« or www.dictum.com



BREAD & TABLE KNIVES

**A BREAD KNIFE**

Bread knife with tried-and-tested serrated edges. With its ergonomically shaped handle, this knife provides a comfortable grip. The full-length blade of wear-resistant chrome-molybdenum-vanadium steel X50CrMoV15 is rustproof, hardness 56 HRC.
Blade length 200 mm
Blade thickness 1.7 mm
Overall length 320 mm

1 Olive Wood

Handle scales made of olive wood with honey-coloured grain. The wood has excellent properties and has therefore been regarded as valuable material for many centuries due to its warm colouring.
130 g

No. 719908**2 Linen Micarta**

Micarta is produced using a special high pressure procedure which combines absorbant material (cellulose material, linen etc.) with epoxy resin. The resulting material is almost indestructible and resistant against oils and chemicals. Micarta provides a comfortable, non-slip grip.
135 g

No. 719909**B JAPANESE BREAD KNIFE**

Long tried-and-tested, super-sharp Japanese serrated knife. It has a long, flexible blade of solid stainless steel, polished to a fine mirror finish, laminated precious wood handle. Rustproof, hardness 56 HRC.

Blade length 250 mm
Blade thickness 1.3 mm
Overall length 375 mm
110 g
No. 719065



▶ For another Brieto bread knife see page 95.

**C TABLE KNIFE BUCKELS**

Whether at the breakfast table or on a picnic - this typically shaped table knife called a »Buckelsmesser« (Buckel = hunchback) has proven itself for over 140 years and has become a classic. This knife is suitable for cutting bread, cheese and sausage, plus its wide blade can be used to thinly spread butter or other spreads. The special shape of the blade is characteristic of the traditional, old German table knife. The spine of the blade is slightly curved and instead of a point, the front of the blade is quite round. The handle scales are mounted on the full-length tang and triple-riveted. Rustproof steel No. 1.4034, double-bevelled, hardness 56 HRC.
Blade length 125 mm
Blade thickness 1.6 mm
Overall length 225 mm
55 g

1 Olive Wood

Handle scales made of olive wood. This type of wood has excellent properties and has therefore been regarded as a valuable material for many centuries due to its warm colouring and honey-coloured grain.

No. 709676**2 Smoked Oak**

Handle scales made of dark smoked oak.

No. 709745**3 Juniper**

Handle scales made of finely grained juniper wood.

No. 709746**4 Pistachio Wood**

Handle scales made of pistachio wood. The attractive chestnut brown colour usually includes decorative darker streaks.

No. 709747**D SNACK SET, 2 PIECES** *Price advantage*

Well prepared:

- Board made of cherry wood with fine grain, dimensions 210 x 150 x 10 mm.
- Easy-care all-purpose knife with rust-proof, triple-layered blade, double-bevelled; sheath made of enju wood; blade length 100 mm, overall length 200 mm, blade thickness 1.2 mm, 30 g.

No. 707935

Inclusive free sharpening pass.
For more information see page 4.



Two free sharpenings

VICTORINOX®



E VICTORINOX® SWISS CLASSIC FOLDING ALL-PURPOSE KNIFE
Handy for on-the-go:
Compact, practical and versatile folding knife with serrated edge, ideal for on-the-go. The blade is securely locked with a liner-lock mechanism. The knife with nylon handle is rustproof, easy to clean and dishwasher safe.
Blade length 110 mm
Blade thickness 1.1 mm
Overall length 230 mm
45 g

1 black No. 708692
2 red No. 708693
3 green No. 708694



F VICTORINOX® SWISS CLASSIC FOLDING VEGETABLE KNIFE
Handy for on-the-go:
Compact, practical and versatile folding knife, ideal for on-the-go. The blade is securely locked with a liner lock mechanism. The knife with nylon handle is rustproof, easy to clean and dishwasher safe.
Blade length 110 mm
Blade thickness 1.1 mm
Overall length 230 mm
45 g

1 black No. 708695
2 red No. 708696



G VICTORINOX® KNIVES, 3-PIECE SET
Handy, 3-Piece Set, suitable for smaller cutting work in the kitchen. The knives with black nylon handle are rustproof, easy to clean and also dishwasher-safe.

The set includes:

- Serrated all-purpose knife: versatile in use, also suitable as a table knife; blade length 110 mm, overall length 220 mm
- Serrated vegetable knife: for cutting and chopping fruit and vegetables; blade length 80 mm, overall length 190 mm
- All-purpose knife: for cutting, cleaning and peeling of fruit and vegetables, also suitable for chopping garlic, herbs etc.; blade length 80 mm, overall length 190 mm

No. 709595

H VICTORINOX® VEGETABLE KNIFE
Handy fruit, vegetable, and paring knife. This knife with a nylon handle is rustproof, easy to clean, and dishwasher-safe.
Blade length 80 mm
Blade thickness 1 mm
Overall length 190 mm
20 g
No. 709659



All Victorinox knives are suitable for the dishwasher.



A VICTORINOX® ALL-PURPOSE KNIFE
Versatile serrated knife with a black nylon handle. Can also be used as a table knife. The knife is rustproof, easy to clean and also dishwasher-safe.
Blade length 110 mm
Blade thickness 1.1 mm
Overall length 220 mm
30 g
No. 709599

B VICTORINOX® VEGETABLE KNIFE WITH SERRATED EDGES
Handy fruit, vegetable and peeling knife with serrated edges. The knife with nylon handle is rustproof, easy to clean and dishwasher-safe.
Blade length 80 mm
Blade thickness 1 mm
Overall length 190 mm
20 g
No. 709649

C VICTORINOX® BONING KNIFE FLEXIBLE
Boning knife with curved, flexible blade. The ergonomically shaped polyamide handle has a very comfortable anti-slip surface and can be sterilized at a temperature of 150 °C. Double bevel, rustproof.

1 Blade length 120 mm
Blade thickness 1.4 mm
Overall length 255 mm
85 g
No. 709629

2 Blade length 150 mm
Blade thickness 1.4 mm
Overall length 280 mm
90 g
No. 709624

D VICTORINOX® BUTCHER KNIFE
Butcher Knife for portioning. The ergonomically shaped polyamide handle has a very comfortable anti-slip surface and can be sterilized at a temperature of 150 °C. Double bevel, rustproof.
Blade length 240 mm
Blade thickness 2 mm
Overall length 380 mm
150 g
No. 709620

Inclusive free sharpening pass. For more information see page 4.

 Two free sharpenings



E VICTORINOX® STICKING KNIFE
Sticking knife for carving meat. The ergonomically shaped polyamide handle has a very comfortable anti-slip surface and can be sterilized at a temperature of 150 °C. Double bevel, rustproof.

1 150 mm
Blade thickness 2.3 mm
Overall length 285 mm
115 g
No. 709623

2 180 mm
Blade thickness 2.3 mm
Overall length 310 mm
120 g
No. 709622

F VICTORINOX® FILLETING KNIFE

Knife with extra narrow blade for filleting fish. The ergonomically shaped polyamide handle has a very comfortable anti-slip surface and can be sterilized at a temperature of 150 °C. Double bevel, rustproof.

Blade length 155 mm
Blade thickness 1.7 mm
Overall length 285 mm
75 g
No. 709625

G VICTORINOX® BONING KNIFE

Boning Knife with narrow blade, ideal for carving and boning. The ergonomically shaped polyamide handle has a very comfortable anti-slip surface and can be sterilized at a temperature of 150 °C. Double bevel, rustproof.

Blade length 95 mm
Blade thickness 1.5 mm
Overall length 230 mm
80 g
No. 709621

H VICTORINOX® FISH KNIFE

This rustproof knife with its slim, flexible blade is ideal for gutting and filleting fish. With practical fish scaler at the back of the blade. The ergonomically shaped polyamide handle ensures a comfortable and slip-proof grip whatever the weather. The surface can be sterilized up to a temperature of 120 °C.

Blade length 160 mm
Blade thickness 1.2 mm
Overall length 280 mm
70 g
No. 709653



HUNTING AND OUTDOOR KNIVES

with extremely sharp and durable multi-layered blades

We offer a wide range of knives made by renowned manufacturers and many of them are hand-forged in traditional Japanese workshops, in order to best meet the requirements related to fishing, outdoor and hunting activities.

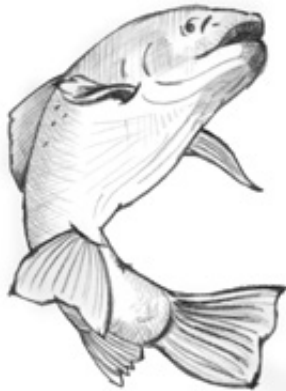

Knives for Fishermen

Knives for fishing activities have long, slender blades that can also be used for filleting.



Folding and Outdoor Knives

DICTUM offers an extensive selection of high-quality folding and pocket knives of renowned international manufacturers, including Japanese manufacturers such as Nagao, Hiro and Mcusta, as well as European manufacturers such as Atelier Perceval, Claude Dozorme, Arto, Lionsteel, Maserin, Tecnocut, Massimo Salice Sanna and Svörd.



Hunting Knives

Many of our fixed-blade hunting knives are made in traditional forges in Japan and Sweden.

STEEL - THE CORE OF EVERY KNIFE

Important characteristics of a steel are its edge retention, its corrosion-resistance and its sharpenability, which vary according to the kind of alloy. The right choice of the blade steel therefore depends on one's requirements and on how much time one is willing to invest in the knife care. There are multiple working steps to make a ready-to-use knife from a blade blank - the different steel types give the blades a different hardness, structure and shape. The most commonly used steel types:



- **Classic carbon steel** (one or more layers) is not rustproof. The blade must therefore be dried after use and regularly oiled. However, it achieves ultimate sharpness and is easy to sharpen. The unalloyed steel has a very high degree of purity, is especially hard and has a fine martensitic structure. Therefore, it can achieve an extraordinary sharpness and retain it for a long time.

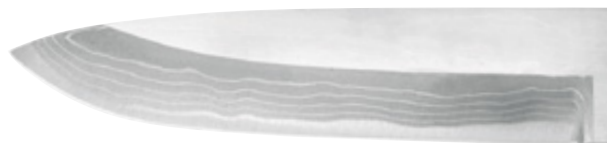

- **Cutting layer made of carbon steel, embedded between several layers of stainless steel** (triple- or multi-layered). The blade is rustproof except for the exposed part of the cutting layer, which may oxidise. A good compromise between maintenance effort and sharpenability. The cutting layer has similar features as those described under »Classic carbon steel«.



- **Stainless steel** (one or more layers) is rustproof and does not need to be oiled. The high chromium content, however, reduces the sharpenability. Chromium tends to clog the sharpening stone and increases burr formation.



斎藤



SAJI - JAPANESE HUNTING AND OUTDOOR KNIVES

The Japanese master smith Takeshi Saji uses traditional components to create utility knives that have revolutionised the market - not only in Japan. Blades of multi-layered steel make these knives feasts for the eyes, while the steel used for the cutting edges lends exceptional sharpness and durability. The size of the handles is designed for European hands, while a firm attachment of the tang and anti-slip features ensure that these knives are also ideal for heavy use. Saji's knives are characterised by highly functional design and a rustic finish alongside exceptional value for money. The master engraves his own signature by hand on each of the blades. Double-bevelled.



A SAJI HUNTING KNIFE, KAWA KURO
 This sturdy knife will withstand all challenges during your hunting or trekking activities. The oak wood handle, wrapped in black ray skin, ensures a secure grip even under wet conditions. Scabbard made of magnolia wood with leather mounts, belt hook. Gunmetal finished

11-layered blade with Suminagashi pattern. Core cutting layer of White Paper Steel, hardness 60 HRC, not rustproof.
 Blade length 110 mm
 Blade thickness 4.5 mm
 Overall length 230 mm
 190 g
No. 719260



Fitting leather sheath
No. 709883



“ THE KNIFE FOR THE LONELY WOLF.

manager magazin



B SAJI HUNTING KNIFE, KAWA AKA
 11-layered Suminagashi blade, cutting layer of White Paper Steel. Oak handle with red ray skin wrapping. Magnolia wood scabbard with leather mounts, belt loop. Urushi varnishing. Not rustproof,

hardness 60 HRC.
 Blade length 130 mm
 Blade thickness 4.7 mm
 Overall length 250 mm
 180 g
No. 719268



Fitting leather sheath
No. 709884



C SAJI HUNTING KNIFE CHERRY BARK
 With this generously dimensioned utility knife the master blacksmith reanimates the traditional art of cherry tree bark handwork (Kaba Zaiku). The beautifully grained, breathing skin of the cherry tree adds class to the handle and sheath. The strong blade of 11-layered Suminagashi

steel is amazingly sharp and durable even under the most demanding conditions. Cutting core of White Paper Steel, hardness 60 HRC, not rustproof.
 Blade length 155 mm
 Blade thickness 5.5 mm
 Overall length 280 mm
 250 g
No. 709036



Fitting leather sheath
No. 709882



Inclusive free sharpening pass. For more information see page 4.

 Two free sharpenings



A

A SAJI HUNTING KNIFE TANGO CHIRIMEN

A special feature of this hunting knife is the wrapping of knife handle and sheath with the fabric called »Tango Chirimen« and stained dark brown rattan. The silk fabric is produced in the area Tango (prefecture Kyoto). A special weaving technique gives the cloth strength and provides a distinctive beautiful ripple

pattern. Knife handle of oak wood, sheath made of magnolia wood with cord. 11-layered blade with a cutting edge of White Paper Steel. Hardness 60 HRC, not rustproof. Blade length 130 mm Blade thickness 4.5 mm Overall length 250 mm 210 g **No. 719365**



Fitting leather sheath **No. 709886**



B

B SAJI HOCHO BAMBOO

Simply classic: The magnificently structured blade of 17-layered Suminagashi steel is based on the strict shape of a Kozuka (a side-knife for use with a Japanese sword) and offers an attractive contrast to the magical natural bamboo. Handle and sheath are made of two glued scales wrapped with

bamboo and lacquered. Carrying cord and lovely silk pouch included. Cutting layer of White Paper Steel, hardness 60 HRC, not rustproof. Blade length 100 mm Blade thickness 4 mm Overall length 210 mm 85 g **No. 709035**



Fitting leather sheath **No. 709881**



C

C SAJI ARCHAIC OUTDOOR KNIFE

A strong triple-layered blade with a core cutting layer of White Paper Steel makes this knife very sharp and durable. The blade is securely anchored in the unvarnished oak handle by a hand forged ferrule. With leather covered magnolia

wood sheath. Hardness 60 HRC, not rustproof. Blade length 135 mm Blade thickness 5 mm Overall length 245 mm 170 g **No. 719280**



Fitting leather sheath **No. 709885**



D

**D SAJI HUNTING KNIFE
ICHINOTANI MOKUME**

A total of 14 layers of copper, brass and stainless steel enclose a cutting core made of Blue Paper Steel, giving the blade of this extravagant Japanese hunting knife an eye-catching structure. Wooden handle wrapped in black-painted rattan. Including a sturdy brown leather sheath with belt loop. Not rustproof, hardness 64 HRC.
Blade length 125 mm
Blade thickness 3.6 mm
Overall length 230 mm
150 g
No. 719858

**E SAJI HUNTING KNIFE
ICHINOTANI**

Fitted with an 11-layered Suminagashi blade and a cutting core made of White Paper Steel. Wooden handle wrapped in black-painted rattan. Not rustproof, hardness 60 HRC. Including a thick leather sheath with belt loop.
Blade length 125 mm
Blade thickness 4 mm
Overall length 230 mm
150 g
No. 719857

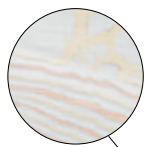

F

**F SAJI HUNTING KNIFE
HINOMOTO**

The strong blade made of 11-layered Suminagashi steel has a cutting core of Blue Paper Steel, which is well-known for its sharpness and edge retention. In the outer layers, the smith uses a combination of copper, brass and stainless steel to give the blade a fascinating look. The light-coloured rattan wrapping offers an

attractive contrast with the black paint on the wooden handle. Ferrule with hand guard. Including a thick black leather sheath with belt loop. Not rustproof, hardened to 64 HRC.
Blade length 135 mm
Blade thickness 3.9 mm
Overall length 270 mm
200 g
No. 719863



G

**G SAJI OUTDOOR KNIFE
KONOHA**

Puristic: The Konoha Hocho is characterised by a clear shape and rustic finish. Powerful triple-layered blade in a willow leaf form (iron/White Paper Steel/iron), with an akagashi (oak) handle, belt sheath of

formed naturally tanned leather and karabiner. Hardness 60 HRC, not rustproof.
Blade length 80 mm
Blade thickness 3.5 mm
Overall length 185 mm
70 g
No. 719139



**Inclusive free sharpening pass.
For more information see page 4.**

 Two free sharpenings



A SAJI HUNTING KNIFE
STAG HORN
 Strong hunting knife with 11-layered blade of Japanese Damascus steel and traditional stag horn handle. For this knife, Japanese stag horn originating from Sika deer from the Hokkaido region was used, whose individual structure makes each knife unique. Cutting core

layer of White Paper Steel, hardness 60 HRC, not rustproof. Comes with strong leather sheath with belt hook.
 Blade length 150 mm
 Blade thickness 4.8 mm
 Overall length 290 mm
 245 g
No. 719368



B SAJI HUNTING KNIFE, OAK
 Generously dimensioned hunting knife with oak handle and hand guard. 11-layered Suminagashi blade; core layer made of White Paper Steel. Comes with leather sheath, not rustproof, hardness

64 HRC.
 Blade length 140 mm
 Blade thickness 4 mm
 Overall length 280 mm
 210 g
No. 708973



C SAJI OUTDOOR KNIFE, STAG HORN
 Small, handy outdoor knife with buck-horn handle. 11-layered Suminagashi blade core layer made of White Paper Steel. Leather belt holster with snap

hook. Hardness 64 HRC, not rustproof.
 Blade length 105 mm
 Blade thickness 3.4 mm
 Overall length 215 mm
 100 g
No. 708972



D SAJI OUTDOOR KNIFE, OAK
 Small outdoor knife with round oak wood handle. The blade consists of a total of 11 layers, the cutting layer is made of durable White Paper Steel. Leather belt holster with snap hook. Hardness 64

HRC, not rustproof.
 Blade length 95 mm
 Blade thickness 3.5 mm
 Overall length 210 mm
 80 g
No. 708974





E SAJI HUNTING KNIFE LINEN MICARTA

The robust linen micarta handle scales are fitted directly to the one-piece tang and riveted in place by two stainless steel pins. The size of the handle is designed with European hands in mind, while the finger recesses guarantee a firm grip and precise guidance of the blade. The cutting core made of VG-10 steel is enclosed within 30 layers of nickel Damascus steel. The handle has a brass thong hole and the knife comes with a black leather sheath that can be worn on the belt. Rustproof, hardness 60 HRC.

1 Saturn
Blade length 100 mm
Blade thickness 5 mm
Overall length 230 mm
280 g
No. 719740

2 Bat
Blade length 100 mm
Blade thickness 4.1 mm
Overall length 225 mm
235 g
No. 719862



F HUNTING AND OUTDOOR KNIFE »KEN NATA«

This extremely practical knife is the result of the cooperation between a Japanese knife smith and several hunters. It is very light, stable, very sharp and easy to resharpen. Triple-layered blade with core layer made of Blue Paper Steel and of softer, more flexible steel side layers.

Bowie style blade shape (Duckbill). The flat part of the blade has a hammered forging surface. Signature of the master smith partly coloured with gold. Traditional, forged iron bolster with long hand guard. Handle made of fire-hardened, thus weight-reduced oak, stained black and brushed. Robust saddle leather sheath with belt loop. Safety strap. Hard-



ness 62 HRC, not rustproof.
Blade length 135 mm
Blade thickness 4 mm
Overall length 260 mm
170 g
No. 709158



G OUTDOOR KNIFE »MORIYUKI«

Whether hunting or trekking, you can rely on this sturdy outdoor knife even under the hardest conditions. The strong, ergonomically shaped oak handle is decorated with rivets. The gunmetal-finished blade has a core layer of tough Blue Paper Steel, is 5 mm thick and hand signed by the master blacksmith.

The meticulously worked robust leather sheath has two fastening straps. It can be worn on a belt. Hardness 63 HRC, not rustproof.
Blade length 160 mm
Blade thickness 5 mm
Overall length 280 mm
280 g
No. 719284



Inclusive free sharpening pass.
For more information see page 4.

 Two free sharpenings



A HUNTING AND OUTDOOR KNIFE »KEIRYU-TO«

Light and handy Japanese hunting and outdoor knife with a handle made of stained oak wood. The distressed surface of the handle ensures a good grip in the hand, while the large hand guard prevents any injuries from contact with the cutting edge. Forging the triple-layered blade by hand, the smith uses a cutting edge of White Paper Steel that is characterised by superb sharpness and durability. The outer layers are made of softer iron, and the surface of the blade is hammered. Includes a leather sheath

with belt loop. The blade bears the smith's signature. Hardness 59 HRC, not rustproof. Blade length 120 mm Blade thickness 2.5 mm Overall length 240 mm 145 g

No. 719861



B HUNTING KNIFE WITH OAK WOOD HANDLE

This exceptional knife features a clip-point blade. The hammered forging surface contributes to create the archaic appearance. The cutting core of Blue Paper Steel is hard and tough at the same time and may be honed to a razor sharp edge. The 32 outer layers create a very nice Damascus structure. The Loveless

design rivets are made of stainless steel and brass. This sturdy knife comes with a high-quality saddle leather sheath (with belt loop). Hardness 64 HRC. Not rustproof.

Blade length 110 mm Blade thickness 4 mm Overall length 240 mm 170 g

No. 719349



C HUNTING KNIFE HIRO, DESERT IRONWOOD

This reliable companion for all outdoor activities is entirely convincing thanks to its smart blend of functionality and harmonic design. 32 side layers of stainless steel combined with a VG-10 cutting edge produce a full-length blade with an appealing Suminagashi pattern - perfectly matched by handle scales made of grained desert ironwood. The wood features a high density and is therefore

particularly resistant to humidity. Black liner material connects the wood with the nickel silver cheeks, which come with a hand guard. Leather sheath with belt loop.

Hardness 60 HRC, rustproof. Blade length 115 mm Blade thickness 3.6 mm Overall length 225 mm 170 g

No. 719530





D HUNTING KNIFE
 Hand-forged knife with an archaic appearance, made of 16-layered Suminagashi steel and a core of Blue Paper Steel with excellent sharpness retention (60 HRC). The red notch is the signature of the blacksmith. Not rustproof. Cord-

wrapped handle, leather sheath. Blade length 90 mm Blade thickness 3 mm Overall length 230 mm 130 g **No. 719215**

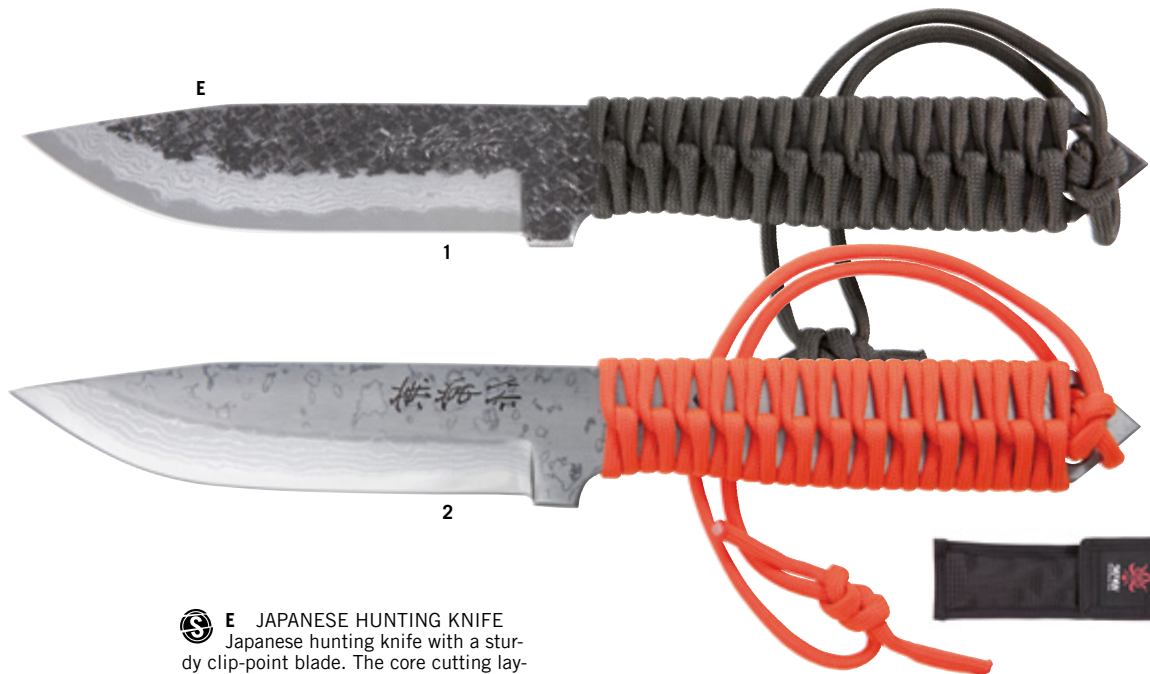

E JAPANESE HUNTING KNIFE
 Japanese hunting knife with a sturdy clip-point blade. The core cutting layer of durable Blue Paper Steel is encased in 14 side layers of Suminagashi steel. Handle wrapped in green parachute cord, comes in nylon case with belt loop. Blade with hand guard and signature, hardness 61 HRC, not rustproof. Blade length 120 mm Overall length 260 mm

1 Karasu
 Blade with black forged skin and a distinctive hammer mark pattern; on the lower part the blade has a Suminagashi pattern. Blade thickness 3.8 mm 190 g **No. 719868**

2 Shu-Karasu
 Blade with distinctive Suminagashi pattern. Blade thickness 3.2 mm 165 g **No. 719869**



F JAPANESE HUNTING AND OUTDOOR KNIFE KUROTSUNO
 Japanese hunting and outdoor knife with clip-point blade; upper part of the blade has black forged skin and light hammer marks, lower part has a Suminagashi pattern. The core cutting layer of Blue Paper Steel is encased in 14 layers of steel. Handle wrapped in green parachute cord,

comes in nylon case with belt loop. Blade with signature, hardness 61 HRC, not rustproof. Blade length 120 mm Blade thickness 4 mm Overall length 240 mm 165 g **No. 719867**



Inclusive free sharpening pass.
 For more information see page 4.

 Two free sharpenings

MERCURY®

Mercury, founded in 1950, has its headquarters in the well-known Italian »knife capital« Maniago. Originally, the company specialised in the complex production of multifunctional pocket knives. Meanwhile, the product range includes a large selection of folding knife models as well as hunting and outdoor knives with fixed blades.



A

A MERCURY® HUNTING AND OUTDOOR KNIFE OLD CHAP
 Made of one single piece of 440C steel and with its blade thickness of 4 mm, the »Old Chap« is also up to heavy use. The blade is processed in a special procedure and thus receives its rustic appearance. Handle scales made of olive wood with honey-coloured grain. Supplied with a sturdy brown leather sheath with belt loop. Rustproof 440C steel, hardness 59 HRC.
 Blade length 130 mm
 Blade thickness 3.8 mm
 Overall length 260 mm
 180 g
No. 708828



TECNOCUT

Like most major Italian knife manufacturers, the company Tecnocut is based in the »knife capital« of Maniago. Tecnocut has been constantly developing and producing new knife models under the brand name Viper since it was founded in 1987.



B

1

2

B VIPER® GIANGHI
 This robust hunting and outdoor knife is the result of a collaborative project with Fabrizio Silvestrelli, a member of the Italian Knifemakers' Guild. The name Gianghi comes from the old Persian language and means »hunter«. The groove on the blade back serves as a thumb rest to ensure a secure hold. Comes in a sturdy leather sheath with belt loop and a leather strap; the knife can be worn either straight or

crossways on the belt. Blade of rustproof Böhler-N690 steel, which is easy to care for. Hardness 60 HRC.
 Blade length 120 mm
 Blade thickness 2.8 mm
 Overall length 250 mm



1 Olive Wood
 Handle scales made of olive wood with honey-coloured grain. The wood has excellent properties and has therefore been regarded as a valuable material for many centuries due to its warm colouring.
 220 g
No. 708818

2 Micarta
 Micarta is produced in a special high-pressure process by combining an absorbent carrier material (cellulose, linen, etc.) with epoxy resin. The material is almost indestructible and resistant to acids and oils.
 240 g
No. 708819

LIONSTEEL®

Since 1969, Lionsteel - located in the Italian »knife capital« Maniago - has been primarily producing utility knives, pocket knives and hunting knives in classical clear shapes using exquisite handle materials.

C LIONSTEEL® HUNTING AND OUT-DOOR KNIFE M1

 Handy, compact all-round knife; versatile for hunting, outdoor activities or camping. The titanium bead is fixed to the lanyard with a screw plug. Blade made of powder-metallurgical Böhler M390 steel. Comes with a sturdy brown leather sheath with belt loop. Rustproof, hardness 61 HRC. Blade length 75 mm. Blade thickness 3 mm. Overall length 170 mm.

* Steel analysis: $C = 1.9 / Si = 0.7 / Mn = 0.3 / Cr = 20 / Mo = 1 / V = 4 / W = 0.6$ (in %)

1 Olive Wood

Handles scales made of olive wood with honey-coloured grain. The wood has excellent properties and has therefore been regarded as valuable material for many centuries due to its warm colouring.

75 g
No. 709910

2 Walnut wood

Handle scales made of fine quality walnut wood.

75 g
No. 709911

3 G10

Handle scales made of black, slightly textured G10. The material is extremely hard and robust, and the textured surface gives it a slip-resistant feel.

90 g
No. 709912



Inclusive free sharpening pass.
For more information see page 4.



Two free sharpenings

D LIONSTEEL® HUNTING KNIFE M2

This robust, handy hunting knife was created in cooperation with the Italian knife forum MCKF. Made from a single piece of wear-resistant D2 steel and with a 4 mm thick blade, it is also suitable for heavy-duty use. The fitted G10 handle scales are attached with two screws and the rough surface ensures a secure grip. Comes with a robust brown leather sheath with belt loop. Hardness 60 HRC. Blade length 90 mm. Blade thickness 4 mm. Overall length 190 mm.

170 g
No. 719596



E LIONSTEEL® HUNTING KNIFE M5

This sturdy hunting knife was designed in cooperation with the knife maker Michele »Molletta« Pensato. The knife is very comfortable to hold and its size fits even large hands. The handle scales of olive wood are slightly serrated, ensuring a secure grip. The

wood has excellent properties and has therefore been regarded as valuable material for many centuries due to its warm colouring. The full-length blade is made of Uddeholm Sleipner steel*, a tough steel with an excellent edge retention. Comes with a sturdy brown leather sheath with belt loop. Hardness 60 HRC, not rustproof.

* Steel analysis: $C = 0.9 / Si = 0.9 / Mn = 0.5 / Cr = 7.8 / Mo = 2.5 / V = 0.5$ (in %)

Blade length 115 mm
Blade thickness 4.5 mm
Overall length 240 mm
200 g
No. 719864



DARKNESS - FUNCTIONAL AESTHETICS

The surface structure of the fixed blade is created by controlled grinding, a special heat treatment creates the unique look, feel and colour.



AFK

The Hungarian knifemaker Attila Kertész has been making hunting knives and exclusive collector's knives by hand since 1986. Since 2004 he is a member of the Hungarian and since 2014 of the German Knifemakers Guild.



HUNTING KNIVES DARKNESS



A HUNTING KNIFE DARKNESS
A special hunting knife:
The extraordinary surface structure of the fixed blade is created by controlled grinding and a specially developed heat treatment. The curved handle provides a comfortable grip. The integral blade of ATS34 steel is rustproof and has a hardness of 59 HRC.

1 Ebony
The handle scales are made of a combination of ebony and leather wrapping. The handmade cowhide pouch is sewn with an attractive pattern, while the two adjustable hanging loops allow the knife to be carried on a belt either straight or at an angle.
Blade length 80 mm
Blade thickness 2.5 mm
Overall length 175 mm
170 g
No. 719588

2 Sheoak
Handle scales made of Australian Sheoak. The handmade cowhide pouch is sewn with an attractive pattern, while the two adjustable hanging loops allow the knife to be carried on a belt either straight or at an angle.
Blade length 80 mm
Blade thickness 1.5 mm
Overall length 175 mm
130 g
No. 709711

3 Sheoak Mini
Handle scales made of Australian Sheoak. With handmade brown cowhide pouch.
Blade length 70 mm
Blade thickness 1.8 mm
Overall length 155 mm
110 g
No. 709712

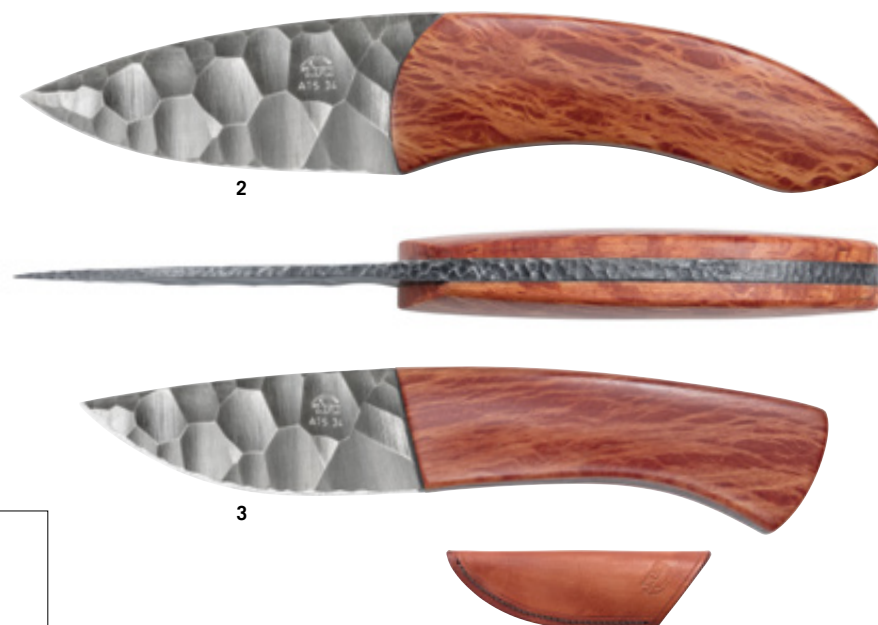

Inclusive free sharpening pass.
For more information see page 4.

Two free sharpenings

A



A KAIKEN
 Kaiken is a variation of the Japanese Tanto and means »short dagger«. The handle scales are made of black, resistant G10. This high-grade glass fibre-reinforced plastic material is made using a specific high-pressure process in combination with epoxy resin. The red lining material between the tang and the softly textured handle scales offers

a nice contrast. Comes with matching black cowhide sheath with red stitching and a belt loop. Double-bevelled blade made of rust-resistant D2 steel, hardness 60 HRC.
 Blade length 125 mm
 Blade thickness 5.8 mm
 Overall length 250 mm
 215 g
No. 719741



**Inclusive free sharpening pass.
 For more information see page 4.**

 Two free sharpenings

B



B HUNTING KNIFE WITH EBONY HANDLE
 This robust hunting knife is made of rust-resistant D2 steel, which has an excellent edge retention and sharpness. The groove on the blade back serves as a thumb rest to ensure a secure hold. The handle scales are made of high-grade Macassar ebony. Two stainless steel jaws

form the transition to the blade. Comes with a handmade cowhide sheath with belt loop. Hardness 60 HRC.
 Blade length 110 mm
 Blade thickness 4.5 mm
 Overall length 235 mm
 230 g
No. 719589





C OUTDOOR KNIFE G10
 Compact all-purpose knife with handle scales made of slightly structured, black G10 material. G10 is a high-grade fibreglass composite created with a special high-pressure procedure in combination with epoxy resin. This makes it extremely hard and durable. The orange inlay is a real eye-catcher and lends the knife a special touch. Comes

with matching softly textured and robust cowhide sheath with orange seams. Double bevelled blade made of rust-resistant D2 steel. Sheath and knife with hanging eyelet. Hardness 59 HRC.
 Blade length 100 mm
 Blade thickness 5.5 mm
 Overall length 230 mm
 185 g
No. 719742



1



2

D HUNTING KNIFE INTEGRAL
 Clear, simple aesthetic design:

A very handy and elegant hunting knife forged from a single piece of steel. The rust-resistant D2 steel is extremely sharp and wear-resistant. The handle scales fit exactly and the ergonomic handle ensures a good, secure grip. With its 9.5 mm thick blade, this solid knife is also capable of heavy-duty application. Comes with robust handmade, cowhide sheath with belt loop. Hardness 60 HRC.

This knife series won first place in the category »Best of Fixed Hunting Knives« at the 2008 Brno knife show.



1 Macassar Ebony
 Handle scales made of Macassar ebony, one of the densest and hardest woods in the world. Jet black.
 Blade length 90 mm
 Blade thickness 9.5 mm
 Overall length 220 mm
 185 g
No. 719586

2 Goldfield
 Handle scales made of reddish-brown wood with a lively grain from Australia.
 Blade length 90 mm
 Blade thickness 7 mm
 Overall length 220 mm
 190 g
No. 709710



CLAUDE DOZORME®

The company was founded in 1902 by Blaise Dozorme in Thiers, the »knife capital« of France. This family-run company combines traditional craftsmanship that has been passed down through the years with modern manufacturing technology. Thus, the range includes both traditional folding knives as well as new interpretations of regional knives. Cutlery and flatware complete the product range.



A CLAUDE DOZORME® SKINNER, STAG

Skinner with integrated gutting hook. Acrylic handle scales with stag motif and staghorn handle inlay. Blade of rustproof X50CrMoV15 steel*, hardness 58 HRC. Comes with leather sheath with belt loop.



* Steel analysis: C = 0.5 / Cr = 15 / Mo = 1 / V = 1 (in %)

Blade length 90 mm
Blade thickness 1.9 mm
Overall length 215 mm
115 g
No. 709715



B CLAUDE DOZORME® HUNTING KNIFE, WILD BOAR

Acrylic handle scales with wild boar motif and wild boar bristle inlay. Blade of rustproof X50CrMoV15 steel*, hardness 58 HRC. Comes with leather sheath with belt loop.



* Steel analysis: C = 0.5 / Cr = 15 / Mo = 1 / V = 1 (in %)

Blade length 95 mm
Blade thickness 4 mm
Overall length 220 mm
190 g
No. 709714

Inclusive free sharpening pass. For more information see page 4.

 Two free sharpenings



C CLAUDE DOZORME® HUNTING KNIFE, STAG

Acrylic handle scales with stag motif and staghorn handle inlay. Blade of rustproof X50CrMoV15 steel*, hardness 58 HRC. Comes with leather sheath with belt loop.



* Steel analysis: C = 0.5 / Cr = 15 / Mo = 1 / V = 1 (in %)

Blade length 140 mm
Blade thickness 3.4 mm
Overall length 265 mm
200 g
No. 709713

► For folding knives with animal motifs made by Claude Dozorme see pages 172 and 173.



SMITH & SONS

Smith & Sons is a young and up-and-coming family-run knife company headquartered in Louisiana, USA. It has been producing excellent quality handmade utility knives for hunting, outdoor and leisure activities since 2011. All knives come with sturdy tanned leather sheaths.



D OUTDOOR KNIFE DESPERADO, G10

The Desperado is a handy and practical knife perfect for outdoor and everyday use. The blade is made of robust, rust resistant D2 steel, which is known for its excellent edge retention and sharpness. The blade's dark patina is created using a special process and not only adds to the knife's good looks, but protects it effectively from oxidation. The handle features a finger groove. Comes with a leather sheath with belt clip. Hardness 60 HRC. Handle scales made of green/black structured G10 material, which is extremely hard and durable. The structured surface furthermore ensures that the knife can be securely held.
 Blade length 75 mm
 Blade thickness 2.7 mm
 Overall length 160 mm
 70 g
No. 709862



E HUNTING AND OUTDOOR KNIFE COMANCHE, MICARTA

A handy and practical knife for hunting and outdoor activities. It features a finger groove, which makes it comfortable to hold. The blade is made of robust, rust-resistant D2 steel, which is known for its excellent edge retention and sharpness. The blade's dark patina is created using a special process and not only adds to the knife's good looks, but effectively protects it from from oxidation. Comes with an elaborate leather sheath with various options for attaching the knife. Blade with finger protection, hardness 60 HRC. The lightly structured handle scales are made of canvas Micarta and are pleasant to hold, including when cold or wet.
 Blade length 95 mm
 Blade thickness 3.5 mm
 Overall length 200 mm
 130 g
No. 709865



F HUNTING AND OUTDOOR KNIFE BRAVE, BOCOTE

A great knife for hunting, outdoor activities and camping. The blade is made of robust, rust-resistant D2 steel, which is known for its excellent edge retention and sharpness. The blade's patina not only adds to the knife's good looks, but effectively protects it from oxidation and is created using a special process. The handle features a finger groove. Supplied with a leather sheath with belt loop. Polished blade, hardness 60 HRC. Handle scales made of grained bocote wood. The decorative hardwood from South America has a light brown colour with dark brown veins.
 Blade length 85 mm
 Blade thickness 3.1 mm
 Overall length 185 mm
 100 g
No. 709868



G HUNTING AND OUTDOOR KNIFE RANCH HAND

A very versatile knife for hunting, outdoor activities and camping. It features a finger groove, which makes it comfortable to hold and very easy to manage when performing delicate work. The blade is made of robust, rust-resistant D2 steel, which is known for its excellent edge retention and sharpness. The blade's dark patina is created using a special process and not only adds to the knife's good looks, but effectively protects it from oxidation. The back of the blade is decorated by hand. The lightly structured handle scales are made of black canvas Micarta and are pleasant to hold, including when cold or wet. Supplied with a leather sheath with belt clip. Hardness 60 HRC.
 Blade length 70 mm
 Blade thickness 3.7 mm
 Overall length 160 mm
 110 g
No. 709866



BRUSLETTO®

The Norwegian traditional manufacturer Brusletto has been producing knives for hunting, fishing and outdoor activities for more than 100 years. Their knives have always been designed and produced to be practical. Handle and blade are worked to fulfill all functional requirements and to fit securely in the hand. The natural structure of wood creates a unique pattern on each handle knife.





A BRUSLETTO® BAMSEN
Hunting and outdoor knife with handle made of nicely grained olive wood and aluminium ferrules. The blade is made of rustproof Sandvik steel 12C27 with a hardness of 57 HRC. Comes with leather sheath with belt loop.

Blade length 120 mm
Blade thickness 3.5 mm
Overall length 225 mm
150 g
No. 709253



B BRUSLETTO® HUNTING KNIFE FEMUND
Solid hunting knife with robust finger protection. The fitted handle scales made of linen micarta are attached with two screws. The knife also features a thong tube hole. Micarta is a very durable material that ensures a safe and comfortable grip. Rustproof 440C steel blade with a hardness of 58 HRC. Comes with leather sheath with belt loop.

Blade length 105 mm
Blade thickness 3.8 mm
Overall length 235 mm
250 g
No. 709651



Cork handle - knife floats if it drops in water



C BRUSLETTO® FISHERMAN'S KNIFE FISKERN
A perfect knife for all fishermen. The slim blade made of rustproof 440C steel is ideal for eviscerating fish. The handle combination of cork and Nordic birch assures that the knife will not sink in case that it will drop in water - it floats. Comes with leather sheath with belt loop. Hardness 57 HRC.

Blade length 120 mm
Blade thickness 1.7 mm
Overall length 240 mm
55 g
No. 709252



D FIRE STICK (WILDMARKSSTIKAN)
Essential for every trekking tour: When your matches and lighter let you down, then you can always rely on the fire stick to provide you with a warming campfire. Simply rub any steel blade

across the fire stick to create a burst of sparks large enough to easily light dry paper or tinder. Magnesium stick with a reindeer horn handle. With instruction booklet.
Overall length 100 mm
No. 708890

Inclusive free sharpening pass. For more information see page 4.

 Two free sharpenings

CASSTRÖM



Casström is a family-run company based in Lycksele in the Swedish part of Lapland. The company produces both traditional and modern Nordic utility knives for hunting and outdoor activities.



1



2



3



3 Masur birch blue
Blade with flat grind. Ideal for hunting, fishing and finer cuts. Handle scales made of blue dyed, stabilised masur birch. Stabilised wood is extremely resistant, absorbs practically no moisture and is therefore very hygienic and warp-free.
140 g
No. 709722



A CASSTRÖM HUNTING AND OUTDOOR KNIFE FOREST

The Casström SFK (Swedish Forest Knife) is a perfect all-rounder for outdoor, bushcraft and hunting. With its 10 cm blade length, even finer work can be carried out perfectly. Due to the slight bend in the handle, the knife lies ergonomically in the hand. Blade made of Sandvik steel 14C28N*. Black liner material between handle scales and tang. Sturdy leather sheath with belt loop. Rustproof, hardness 59 HRC.
Blade length 100 mm
Blade thickness 3.6 mm
Overall length 220 mm

* Steel analysis: C = 0.62 / Si = 0.2 / Mn = 0.6 / Cr = 14 (in %)



1 Masur birch
Blade with Scandi grind. Robust, versatile knife for hunting, fishing and outdoor activities. Handle scales made of Nordic masur birch. This robust type of wood has a very interesting look due to the contrast between the light-coloured heartwood and dramatic dark-coloured veins showing through the wood.
160 g
No. 709724



2 Micarta
Blade with Scandi grind. Robust, versatile knife for hunting, fishing and outdoor activities. The handle scales with green textured Micarta give a pleasant grip even when it is wet or cold.
180 g
No. 709723



B CASSTRÖM FOLDING KNIFE LARS FÄLT

Universal, robust folding knife with a Scandinavian look. This knife was designed by Lars Fält, an outdoors legend in Sweden. The handle scales are made of hard-wearing masur birch. The rustproof Böhler N690 steel blade is

securely locked by means of a back lock mechanism. Thong hole with leather strap. Hardness 59 HRC.
Blade length 75 mm
Blade thickness 2.8 mm
Overall length 180 mm
100 g
No. 727509



C

C CASSTRÖM LARS FÄLT OUTDOOR KNIFE

Lars Fält is Sweden's outdoors legend. He has trained Swedish and British military units in winter survival and is also the author of many outdoor books as well as the designer of this knife. Due to its Scandinavian design and the Scandi grind, it is a robust, all-purpose outdoor knife. The tough blade is made of Böhler K720* tool steel, a robust and easy-to-sharpen steel. Handle scales made of Nordic masur birch. This robust type of wood has a very interesting look due to the contrast between the light-coloured heartwood and dramatic dark-coloured veins radiating through the wood. Black liner material between handle scales and tang. Comes in a sturdy leather sheath

with belt loop and a leather strap for the thong hole. Not rustproof, hardened to 59 HRC.

* Steel analysis: C = 0.9 / Si = 0.25 / Mn = 2 / Cr = 0.35 / V = 0.1 (in %)

No. 709719



D

1

2

D CASSTRÖM OUTDOOR KNIFE WOODSMAN

The Casström Woodsman Knife with classic Scandi grind is a universal outdoor knife. It was created in cooperation with Roger Harrington, an experienced outdoor expert and knife maker who has been teaching bushcraft and survival for over twenty years. The tough blade is made of Böhler K720* tool steel, a robust and easy-to-sharpen steel. Light a warming campfire with the fire stick, which, guided along the blade of the knife, can be used to generate sparks. Black liner material between handle scales and tang. Comes in a sturdy leather sheath with belt loop and a leather strap for the hanging eyelet. Not rustproof, hardened to 59 HRC.

Blade length 90 mm
Blade thickness 3.6 mm
Overall length 205 mm
145 g

* Steel analysis: C = 0.9 / Si = 0.25 / Mn = 2 / Cr = 0.35 / V = 0.1 (in %)



1 Masur Birch

Handle scales made of Nordic masur birch. This robust type of wood has a very interesting look due to the contrast between the light-coloured heartwood and dramatic dark-coloured veins radiating through the wood.

No. 709727



2 Bog oak

Bog oak wood comes from oak logs that lay airtight under sand or mud in bogs for thousands of years. The handle scales used here are made of 5000 year old English bog oak. The wood has an interesting grain; the colour can vary from black to grey.

No. 709728

**Inclusive free sharpening pass.
For more information see page 4.**



Two free sharpenings



WOODSKNIFE

Harri Merimaa is the third generation to manufacture Nordic hunting and outdoor knives in Kauhava in the northwest of Finland. He leaves the blades with a black forged skin, which not only creates a rustic look but also serves as corrosion protection. Different materials are combined for the handles, each of which is unique due to its natural structure.



A WOODSKNIFE OUTDOOR KNIFE

Birch handle. The blade is made of Finnish carbon steel 80CrV2, which offers excellent durability and sharpness. Comes with leather sheath. Not rustproof, hardened to 59 HRC.

Blade length 95 mm
Blade thickness 3.2 mm
Overall length 220 mm
90 g

No. 708961



B WOODSKNIFE HUNTING KNIFE

Masur birch handle with wenge edging. The blade is made of Finnish carbon steel 80CrV2, which offers excellent durability and sharpness. Comes with leather sheath. Not rustproof, hardened to 59 HRC.

Blade length 90 mm
Blade thickness 3.2 mm
Overall length 220 mm
140 g

No. 708960



C WOODSKNIFE HUNTING KNIFE, BEAR PAW

Masur birch handle with elm edging. The blade is made of Finnish carbon steel 80CrV2, which offers excellent durability and sharpness. Comes with leather sheath. Not rustproof, hardened to 59 HRC.

Blade length 120 mm
Blade thickness 3.2 mm
Overall length 240 mm
150 g

No. 708965

**Inclusive free sharpening pass.
For more information see page 4.**

 Two free sharpenings

D WOODSKNIFE HUNTING
KNIFE, WILD BEAR

Masur birch handle with wenge edging. The blade is made of Finnish carbon steel 80CrV2, which offers excellent durability and sharpness. Comes with leather sheath. Not rustproof, hardened to 59 HRC.

Blade length 120 mm
Blade thickness 3.2 mm
Overall length 250 mm
160 g

No. 708964



E WOODSKNIFE HUNTING
KNIFE, LAPP KNIFE

Masur birch handle with wenge edging. The blade is made of Finnish carbon steel 80CrV2, which offers excellent durability and sharpness. Comes with leather sheath. Not rustproof, hardened to 59 HRC.

Blade length 145 mm
Blade thickness 3.2 mm
Overall length 275 mm
165 g

No. 708966



F WOODSKNIFE HUNTING
KNIFE, WILD WOLF

Masur birch handle with wenge edging. The blade is made of Finnish carbon steel 80CrV2, which offers excellent durability and sharpness. Comes with leather sheath. Not rustproof, hardened to 59 HRC.

Blade length 100 mm
Blade thickness 3.2 mm
Overall length 230 mm
115 g

No. 708963



WOODSKNIFE KNIFE PENDANT

G WOODSKNIFE MINI KNIFE PENDANT, WRAPPED HANDLE

Small knife pendant with bent tang and wrapped handle. The blade is made of Finnish carbon steel 80CrV2, which offers excellent durability and sharpness. Comes with leather sheath. Not rustproof, hardened to 59 HRC.

Blade length 55 mm
Blade thickness 3.2 mm
Overall length 115 mm
35 g

No. 708968



H WOODSKNIFE MINI KNIFE PENDANT

Small knife pendant with bent tang. The blade is made of Finnish carbon steel 80CrV2, which offers excellent durability and sharpness. Comes with leather sheath. Not rustproof, hardened to 59 HRC.

Blade length 55 mm
Blade thickness 3.2 mm
Overall length 120 mm
35 g

No. 708969





KARESUNDOKNIVEN®

The knife manufacturer Karesuando Kniven is located in the village of the same name, Karesuando, which lies about 300 km north of the Arctic Circle. There, various knife models are manufactured in the traditional Nordic design. Experience gained from daily use under the toughest conditions has determined and shaped the contours of these knives. All the materials used come from the natural surroundings in the immediate vicinity of the manufacturer.





A HUNTING KNIFE »DAMASK«
 Exclusive Nordic style knives for demanding requirements:
 The brightly patterned blade is made of rustproof Damasteel. Manufactured in Sweden, the Damascus steel blade is produced by powder metallurgy using the sintered and forged steel types RWL34 (»light« patterns) and PMC27 (»dark« patterns). The handle is fashioned from stained Nordic curly birch with a reindeer horn ferrule and a brass hand guard. Supplied in a robust cowhide sheath. Rustproof, hardened to 58 HRC.
 Blade length 80 mm
 Blade thickness 3 mm
 Overall length 195 mm
 95 g

- Striped Damascus
- 1 No. 709061**
- Rose Damascus
- 2 No. 709103**



**Inclusive free sharpening pass.
 For more information see page 4.**

-  Two free sharpenings
-  Lifetime sharpening



B NORDIC HUNTING KNIFE
»THE BOAR«

Ideal for hunting and trekking: Robust, rustproof Sandvik 12C27 blade, ergonomic handle of stained masur birch, brass hand guard, leather sheath with belt loop. Hardness 57 HRC.

Blade length 95 mm
Blade thickness 3 mm
Overall length 215 mm
100 g
No. 709097



C OUTDOOR KNIFE »VUONJAL«

Due to its very compact design, this lightweight and easy-to-handle outdoor knife is ideal for outdoor activities. The functional leather sheath is decorated with ornaments and can be fastened to the belt for transportation. Handle made of robust nordic masur birch with

reindeer horn insert. The blade is made of rustproof Sandvik 12C27 steel. Hardness 57 HRC.

Blade length 65 mm
Blade thickness 2.3 mm
Overall length 180 mm
80 g
No. 709605



D OUTDOOR KNIFE »ELK«

Robust outdoor knife with rustproof Sandvik 12C27 blade. Stained and oiled masur birch handle and reindeer horn ferrule with a hand guard. Sturdy cowhide sheath with a belt loop. Hardness 57 HRC.

Blade length 95 mm
Blade thickness 3 mm
Overall length 215 mm
95 g
No. 709093



E OUTDOOR-SET *Price advantage*

Three things that people need for their outdoor activities: Karesuando outdoor knife with a rustproof Swedish steel blade and a leather sheath that can be carried on a belt, the ultra-compact Japanese wire saw that, despite of a weight of only 12 g, can saw arm-thick branches, and a fire stick that generates copious sparks when stroked along a knife blade.

Blade length 65 mm
Blade thickness 2.3 mm
Overall length 180 mm
80 g

No. 709606





WOOD JEWEL

Wood Jewel is a small, family-owned workshop based in Finland that has been producing traditional Finnish utility knives since 1986. The handles are made of natural materials such as Nordic masur birch and reindeer horn. All knives come with a sturdy leather sheath.

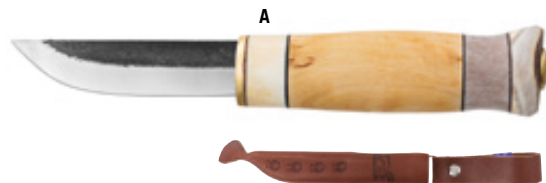

A WOOD JEWEL SMALL KNIFE
Small knife featuring a fixed blade with black forged skin. It is joined to the blade, made of easy-to-sharpen carbon steel 80CrV2, by a brass ferrule. Not rustproof, hardness 58 HRC.
Blade length 60 mm
Blade thickness 2 mm
Overall length 130 mm
30 g
No. 708873

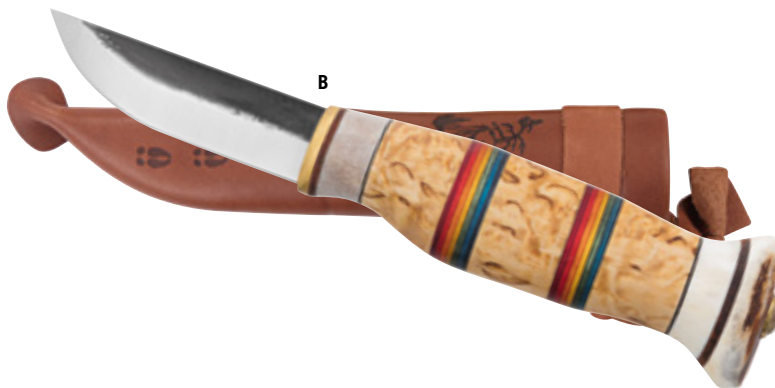

B WOOD JEWEL HUNTING AND OUTDOOR KNIFE »RAINBOW«
The unusual handle combines Nordic masur birch, reindeer horn and leather as well as coloured wood inlays. It is joined to the blade with black forged skin by a brass ferrule. Blades made of easy-to-sharpen carbon steel 80CrV2, not rustproof, hardness 58 HRC.
Blade length 75 mm
Blade thickness 3 mm
Overall length 190 mm
95 g
No. 708871



C WOOD JEWEL HUNTING AND OUTDOOR KNIFE »BIRCH BARK«
The birch bark handle is anti-fungal and anti-bacterial, water-repellent, and slip-proof even when wet. It is joined to the blade with black forged skin and a hammered surface by means of a brass ferrule. Blades made of easy-to-sharpen carbon steel 80CrV2, not rustproof, hardened to 58 HRC.
Blade length 90 mm
Blade thickness 3 mm
Overall length 200 mm
110 g
No. 708870



D WOOD JEWEL HUNTING AND OUTDOOR KNIFE »VUOLU«
Universal hunting and outdoor knife. It is joined by a brass ferrule to the blade, with black forged skin. Blades made of easy-to-sharpen carbon steel 80CrV2, not rustproof, hardness 58 HRC.
Blade length 105 mm
Blade thickness 3 mm
Overall length 220 mm
105 g
No. 708872

E WOOD JEWEL HUNTING KNIFE
»WILLOW GOUSE«

The elaborate handle combines Nordic masur birch, reindeer horn and leather. This is joined to the blade with black forged skin by a brass ferrule. Blade made of easy to sharpen carbon steel 80CrV2, not rustproof, hardness 58 HRC.
Blade length 80 mm
Blade thickness 3.1 mm
Overall length 190 mm
95 g
No. 709762



F WOOD JEWEL OUTDOOR KNIFE WITH FIRE STICK



The ideal companion for all outdoor activities:
Versatile outdoor knife with black forged skin. Handle combination of Nordic masur birch, reindeer horn and leather with brass end. The fire stick with a masur birch and reindeer horn handle enables you to light a warming campfire. Stroke the fire stick along the groove on the blade back specifically designed for that purpose to create big sparks for lighting dry paper or tinder. Blade made of easy-to-sharpen carbon steel 80CrV2, not rustproof, hardness 58 HRC.
Blade length 75 mm
Blade thickness 3 mm
Overall length 190 mm
90 g
No. 709761



G WOOD JEWEL HUNTING AND OUTDOOR KNIFE

Handle in an optimal ergonomic size, made of Nordic masur birch and aspen with a brass ferrule. Blade made of easy-to-sharpen carbon steel 80CrV2, not rustproof, hardness 58 HRC.

Blade length 145 mm
Blade thickness 3 mm
Overall length 275 mm
170 g
No. 709766

► For the Wood Jewel Scoutknife (No. 709763) see www.dictum.com



H WOOD JEWEL FISH KNIFE

This rustproof knife with its slim, flexible blade is ideal for gutting and filleting fish. Handle combination of Nordic masur birch, reindeer horn and leather with brass end. Hardness 57 HRC.
Blade length 160 mm

Blade thickness 1.1 mm
Overall length 270 mm
65 g
No. 709760



Inclusive free sharpening pass.
For more information see page 4.

Two free sharpenings

MORAKNIV® MORAKNIV

Cutting tools have been forged in the Swedish town of Mora for over 400 years. The Mora Knife, developed by Erich Frost over 100 years ago, is synonymous with functionality and reliability.

A MORAKNIV® BASIC
Solid knife for everyday cutting work. The handle made of easy-care plastic with finger protection lies comfortably in the hand. Comes in plastic sheath with clip for fastening to a belt. The carbon steel blade is easy to sharpen. Not rust-proof, hardness 61 HRC.
Blade length 90 mm
Blade thickness 2 mm
Overall length 205 mm
80 g
No. 708833



B MORAKNIV® COMPANION
Universal knife for hunting, outdoor and leisure use. Rubber handle. Comes in plastic sheath with clip for fastening to a belt. Blade of rustproof Sandvik 12C27 steel, hardness 58 HRC.
Blade length 100 mm
Blade thickness 2.5 mm
Overall length 220 mm
85 g
No. 708834



C MORAKNIV® HEAVY DUTY MG (C)
Robust all-purpose knife for hunting, outdoor and leisure use. Rubber handle. Comes in a plastic sheath with clip for fastening to a belt. The blade made of non-rustproof carbon steel is easy to sharpen. Hardness 61 HRC.
Blade length 100 mm
Blade thickness 3.2 mm
Overall length 225 mm
100 g
No. 708832



D MORAKNIV® GARBERG MULTI-MOUNT
A sturdy hunting and outdoor knife with fully integrated blade. The handle made of polyamide with a serrated surface ensures a secure grip. The angular blade back serves as a friction surface for a fire stick. Comes with Multimount carrying system and plastic sheath. Blade of rust-proof Sandvik 14C28N steel, hardness 58 HRC.
Blade length 105 mm
Blade thickness 3.2 mm
Overall length 230 mm
170 g
No. 708831



E MORAKNIV® ELDRIS
The Morakniv Eldris is a small all-purpose knife with a fixed blade in pocket knife format. The handle made of polyamide with a serrated surface ensures a secure grip. The angular blade back serves as a friction surface for a fire stick. Comes with a plastic sheath. Blade of rustproof Sandvik 12C27 steel, hardness 58 HRC.

Blade length 55 mm
Blade thickness 2 mm
Overall length 140 mm
60 g
1 green **No. 708836**
2 black **No. 708835**



1



2



CUDA®



Developed specially for fish processing, these impressive tools feature innovative details and superior technology. Cuda simplifies the professional processing of fish, both on-site and in the kitchen.



Ergonomically shaped handles

F Cuda® FISH FILLET KNIFE PROFESSIONAL

Professional knife for anglers and fisheries. CTS 40A* stainless steel is used for the blade, an extremely corrosion-resistant high-performance steel from the American company Carpenter. The surface is finished with a special titanium nitride non-stick coating, which ensures higher durability and hence lower maintenance requirements. The ergonomically designed Micarta handle fits the hand well. Comes with a precisely fitting sheath made of thermoplastic material, scratch- and impact-resistant, highly weatherproof, provided with a belt loop. Double bevelled, rustproof, hardness 57 HRC.

* Steel analysis: C = 0.7 / Si = 1 / Mn = 1 / P = 0.04 / S = 0.03 / Cr = 17 / Mo = 0.75 (in %)

1 Slim Blade
Flexible, slender blade for precise cuts.
Blade length 160 mm
Blade thickness 1.6 mm
Overall length 310 mm
135 g
No. 709716

2 Wide Blade
Semi-flexible, wide blade.
Blade length 180 mm
Blade thickness 2.2 mm
Overall length 330 mm
180 g
No. 709717



Inclusive free sharpening pass. For more information see page 4.

 Two free sharpenings

G Cuda® FISH FILLET KNIFE
Light fillet knife with a flexible, slim blade made of 1.4116 stainless steel. The surface is coated with titanium nitride, which increases durability. Ergonomic handle with slip-proof surface. Case with belt loop that can be mounted on both sides and water drainage system. Double bevel, rustproof, hardness 56 HRC.
Blade length 150 mm
Blade thickness 1.5 mm
Overall length 295 mm
100 g
No. 709718





Quality

Schlitz



Maserin ITALY
STAINLESS STEEL CW EDINA



Maserin ITALY
STAINLESS STEEL CW EDINA

FOLDING KNIVES

Each knife is an original piece

DICTUM offers an extensive selection of high-quality folding and pocket knives of renowned international manufacturers, including Japanese manufacturers such as Nagao, Hiro and Mcusta, as well as European manufacturers such as Atelier Perceval, Claude Dozorme, Arto, Lionsteel, Maserin, Tecnocut, Massimo Salice Sanna and Svörd.

KINDS OF LOCKING MECHANISMS

Different locking mechanisms have been developed over the years and introduced to increase safety in handling folding knives. The following three mechanisms are the most popular:

- **Back lock mechanism:** A locking lever integrated in the back strap catches the blade root and prevents the blade from folding in. A spring keeps the lever tensioned and ensures safe closure. The locking mechanism can be released by pushing the lever, which unlocks the blade.

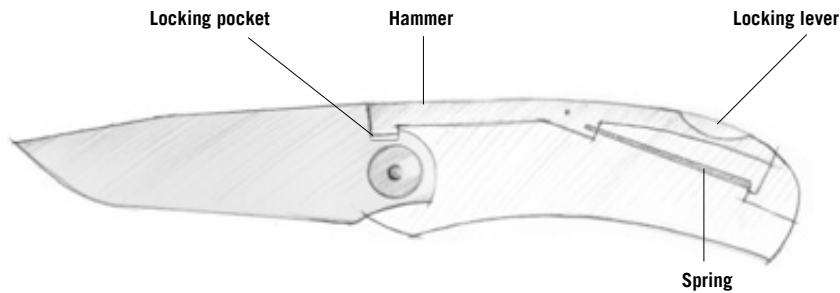

- **Liner lock mechanism:** The centrepiece of the liner lock mechanism is a plate on the inside of the handle scales. This movable part of the liner is slightly curved. It engages when the blade opens and prevents the blade from folding in. Pushing the liner aside unlocks the blade.

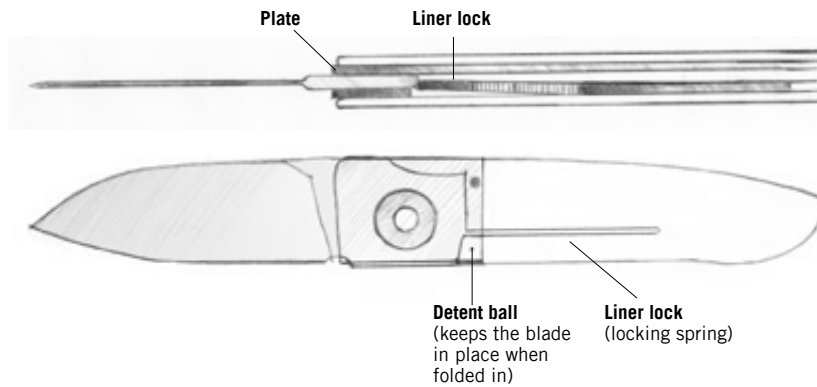

- **Frame lock mechanism:** This locking mechanism is similar to the liner lock mechanism. The significant difference is that the liner is part of the handle frame.

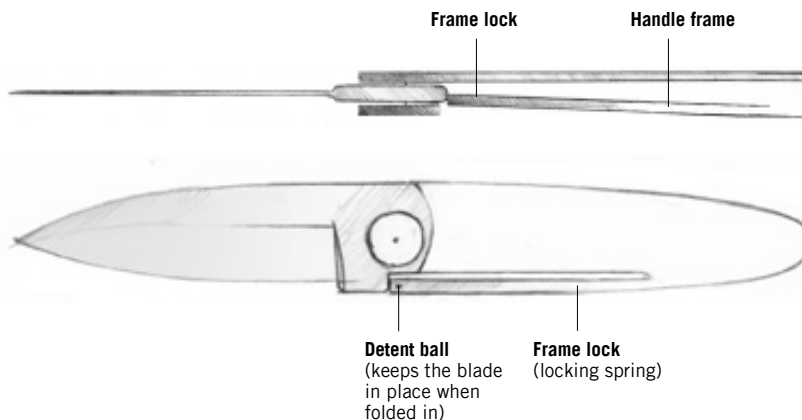

TIMELESS ELEGANCE

Traditional craftsmanship combined with state-of-the-art technology: a frame lock holds the blade of Claude Dozorme's folding knives in place. The combination of technology and workmanship results in a timelessly elegant folding knife that fits comfortably in your pocket.



TRADITIONAL, ARCHAIC AND FUNCTIONAL

In Japan, Higo knives are used for everyday cutting work. In earlier times, everybody from pupils to carpenters carried one of these traditional pocket knives. These knives have no lock, which means that the blade is opened with a lever (in Japanese: chikiri) on the back of the knife and is kept open due to pressure on the lever. Various designs of Higo knives are available. This type of knife, which has been developed and adapted to the needs of its users over decades, is available in very simple and functional versions but also as extremely elegant knives made of multi-layered Damascus steel. But one thing they all have in common is their distinctive archaic, functional shape.



HIGONOKAMI

Traditional Japanese Pocket Knives

In former times, nearly every young man in Japan owned a Higonokami pocket knife. It has been manufactured in the traditional manner for over a century. The blade is set in a handle without locking mechanism and is opened using the lever tang.



A HIGONOKAMI HYORIN
The original by Nagao:
In order to obtain the exceptional patina on the handle surface, the folded brass handle is corroded using a special process. The cutting core made of Blue Paper Steel is flanked by two tougher layers of steel. The black forged skin on the upper part of the blade carries the signature of the knife maker Nagao,

partly inlaid in gold. Double-bevelled, not rustproof, hardness 63 HRC.
Blade length 80 mm
Blade thickness 3.2 mm
Overall length 170 mm
50 g

1 grey **No. 700457**
2 brown **No. 700458**
3 blue **No. 700459**



B HIGONOKAMI MIZU SHIBUKI
The original by Nagao:
The folding sheet steel handle is available in three different colours. The epoxy-resin coating is applied in a special procedure and then fused until it becomes hard. Thus, an attractive raindrop-design appears which creates a three-dimensional effect. The cutting edge made of Blue Paper Steel is surrounded by two softer steel layers.

Double-beveled blade with signature, not rustproof, hardness 63 HRC.
Blade length 75 mm
Blade thickness 3 mm
Overall length 170 mm
46 g

1 black **No. 709580**
2 blue **No. 709581**
3 copper **No. 709582**

Inclusive free sharpening pass.
For more information see page 4.



Two free sharpenings



A HIGONOKAMI BURASU
 The original by Nagao:
 Handle of folded brass plate. Triple-layered carbon steel blade (Blue Paper Steel), not rustproof. Hardness 60 HRC.
 Blade length 70 mm
 Blade thickness 3 mm
 Overall length 160 mm
 40 g
1 Without Sheath
No. 719069
2 With Leather Sheath
No. 719070
3 With Folding Leather Sheath
No. 719073



B MINI HIGONOKAMI
 The original by Nagao:
 Fully functional and handy miniature version of the Japanese Higonokami. Blade of triple-layered carbon steel (SK5 steel cutting layer), simple finish, brass plate handle. Hardness 55 HRC, not rustproof.
 Blade length 40 mm
 Blade thickness 2.45 mm
 Overall length 90 mm
 16 g

1 With bell
No. 709043
2 With leatherette case
 Suitable as key pendant.
No. 719628



C HIGONOKAMI BLACK WITH FORGED SKIN
 The original by Nagao:
 Handle is made of galvanized sheet metal. Triple-layered carbon steel blade (Blue Paper Steel) with black forged skin, not rustproof. Hardness 60 HRC.
 Blade length 75 mm
 Blade thickness 3 mm
 Overall length 175 mm
 50 g

1 Without Sheath
No. 700467
2 With Leather Sheath
No. 700468
3 With Folding Leather Sheath
No. 700469



D HIGONOKAMI BURASU WITH FORGED SKIN
 The original by Nagao:
 Handle of folded brass plate. Triple-layered carbon steel blade (Blue Paper Steel) with black forged skin, not rustproof. Hardness 60 HRC.
 Blade length 75 mm
 Blade thickness 3 mm
 Overall length 175 mm
 50 g

1 Without Sheath
No. 700500
2 With Leather Sheath
No. 700501
3 With Folding Leather Sheath
No. 700502



E HIGONOKAMI VG-10, RUST-PROOF
 The original by Nagao:
 Folded stainless steel handle. Triple-layered blade with core layer made of rustproof VG-10 steel, hardness 62 HRC.
 Blade length 75 mm
 Blade thickness 2.8 mm
 Overall length 170 mm
 45 g
No. 700461



F HIGONOKAMI SILVER
 The original by Nagao:
 Handle made of folded nickel-plated steel. Carbon steel blade, not rustproof. Double-bevelled, hardness 62 HRC.
 Blade length 75 mm
 Blade thickness 2.3 mm
 Overall length 170 mm
 40 g
No. 709999



G JAPANESE FOLDING KNIFE KOTOH
 Timelessly modern, very light gentleman's pocket knives by Yoshimi Kotoh. The smith, born in 1957, manufactures his knives on Kyushu, Japan's most South-Western island. The triple-layered blade with a cutting layer of rustproof VG-10 steel is set in a handle without locking mechanism and is opened using the lever tang. Comes with a leather pouch. Rustproof, hardness 60 HRC.
 Blade length 60 mm
 Blade thickness 2 mm
 Overall length 145 mm
 20 g



1 Ebony
 Handle scales made of elegant black ebony, one of the densest and hardest woods in the world.
No. 719849

2 Wenge
 Handle scales made of wenge. The richly contrasting, coarse light/dark structure, usually combined with irregular or interlocked grain, gives wenge its exceptionally decorative character.
No. 719848

H HIGONOKAMI »KABAZAIKU«, CHERRY BARK
 The original by Nagao: Handle scales made of grained cherry bark lend an elegant touch to the handle and make every knife unique. Kabazaiku, the traditional art of bark processing, is mainly found in the area around Akita, where the wild cherry tree forms a particularly hard skin in the harsh mountain climate. Blade of triple-layered carbon steel (Blue Paper Steel), not rustproof. Hardness 60 HRC.

1 Large
 Blade length 90 mm
 Blade thickness 2.7 mm
 Overall length 210 mm
 70 g
No. 700506

2 Small
 Blade length 75 mm
 Blade thickness 3 mm
 Overall length 170 mm
 50 g
No. 700505

I HIGONOKAMI »KABAZAIKU«, CHERRY BARK, FORGED SKIN
 The original by Nagao: Handle scales made of grained cherry bark lend an elegant touch to the handle and make every knife unique. Kabazaiku, the traditional art of bark processing, is mainly found in the area around Akita, where the wild cherry tree forms a particularly hard skin in the harsh mountain climate. Blade of triple-layered carbon steel (Blue Paper Steel) with black forging skin, not rustproof. Hardness 60 HRC.

1 Large
 Blade length 90 mm
 Blade thickness 2.7 mm
 Overall length 210 mm
 70 g
No. 700504

2 Small
 Blade length 75 mm
 Blade thickness 3 mm
 Overall length 170 mm
 50 g
No. 700503

J FOLDING KNIFE LINER LOCK CARBON
 Modern Japanese folding knife with titanium-coated plates and stainless steel pins, which provide colour and an interesting contrast to the black carbon

handle scales. The blade consists of 71 layers in total with a distinctive Suminagashi pattern; core cutting layer of 440A steel. The elongated blade back acts as a handle tang to open the blade. The blade is locked by a liner lock mechanism. With

thong hole, rustproof, hardness 56 HRC.
 Blade length 75 mm
 Blade thickness 2.6 mm
 Overall length 185 mm
 80 g
No. 719769



Inclusive free sharpening pass. For more information see page 4.

 Two free sharpenings



A FOLDING KNIFE HIGO-STYLE SUMINAGASHI

The fascinating Suminagashi blade stands out clearly and perfectly matches the snakewood's vivid grain. The wood is mounted to stainless steel plates and is one of the most precious and hardest wood types in the world. The interesting colour fascinates with the scale-like appearance of its grain. The 31-layered blade is securely locked due to the smooth liner lock mechanism, the handle back has an open design. Core cutting layer is made of stainless AUS-8 steel, double-bevelled, hardness 58 HRC. Blade length 70 mm
Blade thickness 2.4 mm
Overall length 185 mm
75 g
No. 719698



B FOLDING KNIFE HIGO-STYLE CARBON

A combination of a classic Japanese blade and a European handle. The attractive pattern of the Suminagashi blade, with a total of 31 layers, stands out clearly. It is opened using the lever tang and is securely locked in place with the smooth liner lock mechanism. For the handle scales made of carbon, thousands of microscopic carbon fibres were woven together and fused with epoxy resin. The result is an extremely durable material which, despite its low density, features considerable tensile and compressive strength. The handle back has an open design with a belt clip. Core cutting layer made of rustproof AUS-8 steel, double-bevelled, hardness 58 HRC. Blade length 80 mm
Blade thickness 2.9 mm
Overall length 185 mm
105 g
No. 719757



C SAJI FOLDING KNIFE

Takeshi Saji is among the most famous master smiths in the Takefu Knife Village. For this Japanese folding knife, handles made of black, slightly textured G10 were mounted on a stainless steel plate. The material is extremely hard and robust, and the textured surface gives it a slip-resistant feel. The blade consists of a total of 31 layers and is securely locked with a liner lock mechanism. The cutting edge made of powder-metallurgically produced SG-2 steel gives this folding knife an extraordinary sharpness and edge-holding capacity. Belt clip made of G10. With thong hole, leather pouch, rustproof blade, hardness 63 HRC. Blade length 70 mm
Blade thickness 2.7 mm
Overall length 165 mm
90 g
No. 719839



Inclusive free sharpening pass. For more information see page 4.

 Two free sharpenings



1



2

D JAPANESE FOLDING AND STEAK KNIFE

These slim, stylish pocket knives available for everyday life, can also be used as steak knives. The handle scales contrast attractively with the blue titanium-coated screws and liners. Thanks to the finger rest, the knife fits comfortably in the hand. The blade is locked securely with a liner lock mechanism; the blade back is uncovered. Comes in leather case. Blade length 100 mm Overall length 225 mm

1 Cocobolo

Handle scales made of reddish-brown cocobolo wood. The attractively patterned blade consists of a cutting core of 440A steel encased in 70 layers of rustproof steel. Rustproof, hardness 56 HRC. Blade thickness 2.3 mm 60 g **No. 719743**



2 G10

Handle scales made of lightly structured black G10, a high-quality fibreglass composite produced in a special high-pressure process combined with epoxy resin. The material is very hard and resistant. The polished blade of rust-resistant D2 steel is characterised by excellent edge-holding capacity and sharpness. Hardness 60 HRC. Blade thickness 2.5 mm 75 g **No. 719744**



E FOLDING KNIFE COCOBOLO

A total of 30 outer layers form an impressive Suminagashi pattern around the medial cutting layer made of rust-proof AUS-8 steel. The blade is opened using the lever tang and is securely locked in place with a smooth liner lock mechanism. Attractive cocobolo wood, a precious wood with deep red heartwood striped with dark brown to black grain, is used for the handle scales. The slight indentations in the surface structure ensure a comfortable grip. The handle back has an open design with a hanging loop. Double-bevelled, hardness 58 HRC. Blade length 80 mm Blade thickness 2.7 mm Overall length 190 mm 80 g **No. 719756**



F FOLDING KNIFE HUNTER

Sturdy folding knife with good-sized handle scales of structured G10. The high-quality fibreglass composite is manufactured using a special high-pressure process in combination with epoxy resin. The material is extremely hard and robust, and the surface gives it a slip-resistant feel. The cutting edge of 440A steel is encased in 70 layers of Suminagashi steel, creating an attractive appearance. You open the blade with the handle tang and lock it with a liner lock mechanism. With thong hole, rustproof, hardness 56 HRC. Blade length 90 mm



Blade thickness 3.4 mm Overall length 215 mm 150 g **No. 719758**





Horn handle scales make each knife unique

A FOLDING KNIFE SUMINAGASHI
 The harmonious design of this stylish folding knife is fascinating. The structure of the 31-layered Damascus steel, which is not only found on the blade, but also in the handle jaws, is quite impressive. The finger groove makes it easy to swing out the rustproof blade, which is securely locked in place thanks to the back lock mechanism. Core cutting layer 440C steel, rustproof, hardness 57 HRC.

1 Stag Horn, Small
 Blade length 60 mm
 Blade thickness 2.1 mm
 Overall length 140 mm
 70 g
No. 719752

2 Stag Horn, Large
 Blade length 75 mm
 Blade thickness 2.3 mm
 Overall length 175 mm
 100 g
No. 719753

3 Ebony Wood, Small
 Blade length 60 mm
 Blade thickness 2.1 mm
 Overall length 140 mm
 70 g
No. 719754

4 Ebony Wood, Large
 Blade length 75 mm
 Blade thickness 2.3 mm
 Overall length 175 mm
 95 g
No. 719755



B SAJI FOLDING KNIFE PETTY
 Takeshi Saji is among the most famous master smiths in the Takefu Knife Village. For this Japanese folding knife, handles made of black, slightly textured G10 were mounted on a stainless steel plate. The material is extremely hard and robust, and the textured surface gives it a slip-resistant feel. The blade consists of a total of 31 layers and is securely locked with a liner

lock mechanism. The cutting edge made of powder-metallurgically produced SG-2 steel gives this folding knife an extraordinary sharpness and edge-holding capacity. With thong hole, rustproof blade, hardness 63 HRC.
 Blade length 105 mm
 Blade thickness 2.3 mm
 Overall length 235 mm
 120 g
No. 719859





C FOLDING KNIVES »NORTH MAN«

These hand forged blades stand up to the heaviest demands. The mechanics and back lock are solidly made and show no signs of wear even after years of use. Blades of rustproof Japanese Hitachi GIN-1 steel, walnut handle scales. Hardness 57 HRC.

1 Blade length 50 mm
Blade thickness 2.5 mm
Overall length 130 mm
50 g
No. 719513

2 Blade length 70 mm
Blade thickness 3 mm
Overall length 175 mm
105 g
No. 719514



D MINI FOLDING KNIFE »ABALONY«

This Japanese mini folding knife with handle scales of coloured abalone is a real jewel. The lockable blade of highest quality GIN-1 steel (59 HRC, rustproof) is impressively sharp. This knife will be

your constant companion as a fine key ring or a piece of jewellery.
Blade length 35 mm
Blade thickness 1.95 mm
Overall length 85 mm
20 g
No. 709034



E HIRO SUMINAGASHI FOLDING KNIFE

Exquisite knives with extravagant Damascus steel blades and a beautiful pattern, suitable for everyday use. The Suminagashi pattern makes the blade, which is forged with 33 layers of Japanese steel, a real eye-catcher. The cutting edge is made of VG-10 steel. The polished handle scales with nickel silver bolsters create an interesting contrast to the blade. The back lock mechanism ensures that the blade can be locked safely, and the double cam ensures smooth folding. Hardness 60 HRC, rustproof, with hanging eyelet. Comes with a sturdy

leather sheath with belt loop for storage and transport.

Blade length 70 mm
Blade thickness 2.7 mm
Overall length 175 mm
100 g

1 Desert Iron Wood
Handle scales made of desert ironwood with black liner material between the nickel silver bolsters and the handle scales. Desert ironwood has a beautiful gold-brown colour with dark streaks. Due to its high density it is extremely resistant to moisture.
No. 719760



2 Black Micarta
Handle scales made of black paper micarta with red liner material between nickel silver bolsters and the handle scales. Micarta is produced using a special high pressure procedure which combines absorbant material (cellulose material, linen etc.) with epoxy resin. The resulting material is almost indestructible, resistant against oils and chemicals.
No. 719761



Inclusive free sharpening pass. For more information see page 4.

 Two free sharpenings



ATELIER PERCEVAL

The traditional Laguiole en Aubrac forge is one of the most renowned forges in France. The company is located in Espalion, within the »Laguiole Origine Garantie« zone. Each knife is made by a knife smith and is unique because of its handmade components; depending on the design, up to 216 work steps are necessary. The manufacturer gives a lifetime warranty on material or manufacturing defects.

PERCEVAL FOLDING KNIVES L10 DAMASCUS, JADE



**A PERCEVAL FOLDING KNIFE
L10 DAMASK, JADE**

This knife shape closely follows the »Piémontais« model, which has been popular in France for centuries. Due to its splendid rose Damascus structure, the Damasteel Damascus steel blade which is made through a powder-metallurgical process creates a beautiful look. The blade is opened through the extended hinge, a smooth liner lock mechanism makes sure the blade is securely locked. The handle

back has an open design and thus accentuates the puristic design. The rounded shape of the handle lends the knife a very comfortable touch. Comes with a pouch made of ecologically tanned hippopotamus leather and in an attractive gift and storage box. Hardness 57 HRC, rustproof.

Blade length 85 mm
Blade thickness 2.2 mm
Overall length 205 mm
100 g
No. 709825

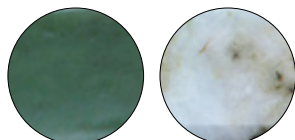

Thanks to the natural materials, every knife is absolutely unique, the colour shades differ from knife to knife. If interested, we are pleased to send you photos of the available models.



**Inclusive free sharpening pass.
For more information see page 4.**



Lifetime sharpening

Green jade: The jade used here (also called nephrite or Canada jade) was extracted from the polar jade mine in British Columbia in Canada. The fascinating dark-green colour of this precious stone comes from the earth elements chromium and iron.

JADE - MYSTICAL JEWEL

Jade is the general term for the often speckled, differently coloured minerals nephrite and jadeite. The semi-precious stones are found in metamorphic rocks that have formed under high pressure. They are mainly found in Myanmar, Canada, China and Japan. This gem has fascinated mankind for thousands of years for its unique beauty. In many cultures, jade was regarded as talisman and protective stone. Furthermore, the stone is attributed a healing affect with regard to kidney diseases as its Greek name »nephrite« means »kidney«. Jade is very difficult to process as its fissile properties cannot be analysed in advance. It needs to be worked into the desired shape in time-consuming procedures such as sawing, drilling and cutting. Every piece is an absolutely unique natural specimen. The colours range from white, all shades of green, yellow and orange to brown. Every knife comes with a certificate identifying the origin of the jade.



FOLDING KNIVES L08



PISTACHIO WOOD 1



SLAKEWOOD 2



GIRAFFE BONE 3

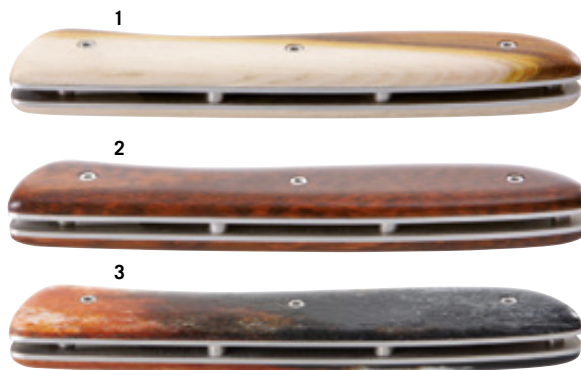

A PERCEVAL FOLDING KNIFE L08

This knife shape closely follows the »Piémontais« model, which has been popular in France for centuries. The blade forged of Sandvik 19C27* steel has been hardened in liquid nitrogen (cryogenic treatment), which makes it extremely durable and easy to sharpen. A smooth liner-lock mechanism makes sure the blade is securely locked. The handle back has an open design and thus accentuates the puristic design. The rounded shape of the handle lends the knife a very comfortable touch. Comes with a pouch made of ecologically tanned cowhide. Hardness 57 HRC, rustproof.

* Steel analysis: C = 0.95 / Si = 0.4 / Mn = 0.65 / Cr = 13.5 (in %)

Blade length 85 mm
Blade thickness 2.3 mm
Overall length 205 mm



1 Pistachio Wood

Handle scales made of French pistachio wood. The attractive chestnut brown colour usually shows decorative darker streaks.

75 g

No. 709830

2 Snakewood

Handle scales made of richly grained snakewood. This kind of wood is among the world's most precious and hardest wood types. The interesting colouring fascinates with its wavy, scale-like pattern.

80 g

No. 709831

3 Giraffe Bone

Handle scales made of stabilized, coloured giraffe bones. Giraffe bones have a rich structure and are extremely robust, which makes them a popular material for handle scales for knives. Comes with a pouch made of ecologically tanned cowhide.

85 g

No. 709832

**Inclusive free sharpening pass.
For more information see page 4.**



Two free sharpenings

THE GIRAFFE BONE HANDLE SCALES
ARE DYED TO CREATE AN
ESPECIALLY VIVID STRUCTURE

Handle scales made of natural resources such as wood, horn or bones are **natural products** and may differ in structure or colour - therefore every knife is absolutely unique.



EBONY 1



GIRAFFE BONE 2



DESERT IRONWOOD 3



MAMMOTH MOLAR 4



MAMMOTH TUSK 5

B PERCEVAL FOLDING KNIFE LO8 DAMASK

This knife shape closely follows the »Piémontais« model, which has been popular in France for centuries. Due to its splendid rose Damascus structure, the Damasteel Damascus steel blade which is made through a powder-metalurgical process creates a beautiful look. A smooth liner lock mechanism makes sure the blade is securely locked. The handle back has an open design and thus accentuates the puristic design. The rounded shape of the handle lends the knife a very comfortable touch. Hardness 57 HRC, rustproof.
Blade length 95 mm
Blade thickness 2.2 mm
Overall length 205 mm

1 *Ebony Wood*

Handle scales made of elegant black ebony wood, one of the densest and hardest woods in the world. Comes with a pouch made of ecologically tanned cowhide.
75 g
No. 709841

2 *Giraffe Bone*

Handle scales made of stabilized, coloured giraffe bones. Giraffe bones have a rich structure and are extremely robust, which makes them a popular material. Every handle scale has a unique colour. Comes with a pouch made of ecologically tanned cowhide.
90 g
No. 709840

3 *Desert Ironwood*

Handle scales made of desert ironwood. Due to its slow growth, desert ironwood from the Arizona desert is one of the hardest and densest wood types. It has a beautiful gold-brown colour with dark streaks. Due to its high density it is extremely resistant to moisture. Comes with a pouch made of ecologically tanned cowhide.
90 g
No. 709842

4 *Mammoth Molar*

Handle scales made of stabilized, coloured mammoth molar. This rare and very fascinating material is about 10 000 years old. The fossil teeth of the Siberian mammoth are won from permafrost zones or glacial ice. Every handle scale has a unique colour. With black liner material between the plates and the handle scales. Comes with a pouch made of hippopotamus leather and an attractive gift and storage box.
90 g
No. 709844

5 *Mammoth Tusk*

Mammoth Tusk handle scales. This rare and very fascinating material is about 10 000 years old. The fossil tusks of the Siberian mammoth are won from permafrost zones or glacial ice. Every handle scale has a unique colour, as the originally creamy white teeth have been deposited under permanent frost over thousands of years and thus changed their colour in various ways. Comes with a pouch made of ostrich leather and an attractive gift and storage box.
80 g
No. 709843

**Inclusive free sharpening pass.
For more information see page 4.**

 Lifetime sharpening



HANDLE MATERIALS

Knife handles are often made of wood or horn. Commonly used types of wood are dense woods such as masur birch, ebony, or precious exotic woods such as desert ironwood or snakewood. They are very dense and have an attractive grain. Wood stores warmth, is especially robust and provides a comfortable grip. Another classic handle material is horn, a very dense material that absorbs hardly any moisture. There is a wide range of types, which can differ considerably in colour and structure. Both handle materials are natural products and can differ in colour and grain.



FOLDING KNIVES L10

 **A PERCEVAL FOLDING KNIFE L10**

This knife shape closely follows the »Piémontais« model, which has been popular in France for centuries. The blade forged of Sandvik 19C27* steel has been hardened in liquid nitrogen (cryogenic treatment), which makes it extremely durable and easy to sharpen. The blade is opened through the extended hinge, a smooth liner lock mechanism makes sure the blade is securely locked. The handle back has an open design and

thus accentuates the puristic design. The rounded shape of the handle lends the knife a very comfortable touch. Comes with a pouch made of ecologically tanned cowhide. Hardness 57 HRC, rustproof.

* Steel analysis: C = 0.95 / Si = 0.4 / Mn = 0.65 / Cr = 13.5 (in %)

Blade length 85 mm
Blade thickness 2.3 mm
Overall length 205 mm

1 Pistachio Wood

Handle scales made of French pistachio wood. The attractive chestnut brown colour usually shows decorative darker streaks.

75 g

No. 709821

2 Ebony Wood

Handle scales made of elegant black ebony wood, one of the densest and hardest woods in the world.

75 g

No. 709822



**Inclusive free sharpening pass.
For more information see page 4.**



Two free sharpenings

A



PISTACHIO 1

EBONY 2



B

 **B PERCEVAL FOLDING KNIFE T45**

Perceval, a French knife-making atelier, developed this elegant, extremely flat folding knife. The modern pocket knife is locked by a frame lock closing mechanism. The belt clip which lies flat against the handle is fitted with Torx screws and is thus removable. The rustproof folding

knife has a blade of X100CrMo13 steel which is mounted on Teflon washers. Handle made of X40CrMo13 steel. Hardness 56 HRC.

Blade length 70 mm
Blade thickness 2.5 mm
Overall length 175 mm
70 g

No. 709229



LE FRANCAIS FOLDING KNIVES WITH DAMASCUS BLADES



A LE FRANCAIS FOLDING KNIFE DAMASK

Inspired by a knife from the 17th century, Perceval developed the model »Le Français«. The powder-metallurgically produced Damasteel Damascus steel blade has a splendid twisted Damascus structure. A smooth liner

lock mechanism makes sure the blade is securely locked. The handle back has an open design and thus accentuates the puristic style. Hardness 57 HRC, rustproof.

Blade length 90 mm
Blade thickness 2.2 mm
Overall length 200 mm



1 Mammoth Tusk

Mammoth tusk handle scales. This rare and very fascinating material is about 10 000 years old. The fossil tusks of the Siberian mammoth are won from permafrost zones or glacial ice. Every handle scale has a unique colour, as the originally creamy white teeth have been

deposited under permanent frost over thousands of years and thus changed their colour in various ways. Comes with a pouch made of ostrich leather and an attractive gift and storage box.

70 g
No. 709814



**Inclusive free sharpening pass.
For more information see page 4.**



Lifetime sharpening





STAG HORN 2



GIRAFFE BONE 3



WACAPOU 4



DESERT IRONWOOD 5



JUNIPER 6



EBONY 7



MAMMOTH MOLAR 8

2 *Staghorn*

Handle scales made of Indian Sambar staghorn. The material's elegant light ground colour shows darker coloured streaks. Comes with a pouch made of ecologically tanned cowhide.

75 g

No. 709812

6 *Juniper*

Handle scales made of juniper. This kind of wood has a brownish colour and a very pleasant peppery scent. In the Middle Ages, this type of wood was popular for smoking purposes, as the smoke was considered to have a cleansing and disinfectant effect. Comes with a pouch made of ecologically tanned cowhide.

60 g

No. 709810

3 *Giraffe Bone*

Handle scales made of stabilized, coloured giraffe bones. Giraffe bones have a rich structure and are extremely robust, which makes them a popular material for handle scales for knives. Comes with a pouch made of ecologically tanned cowhide.

75 g

No. 709813

7 *Ebony*

Handle scales made of elegant black ebony wood, one of the densest and hardest woods in the world. Comes with a pouch made of ecologically tanned cowhide.

75 g

No. 709850

4 *Wacapou*

Handle scales made of Wacapou. This kind of wood comes from South Africa and is very hard and resistant. It ranges from light to chocolate brown in colour and shows fine streaks. Comes with a pouch made of ecologically tanned cowhide.

70 g

No. 709816

8 *Mammoth Molar*

Handle scales made of stabilized, coloured mammoth molar. This rare and very fascinating material is about 10 000 years old. The fossil teeth of the Siberian mammoth are won from permafrost zones or glacial ice. Every handle scale has a unique colour. With black liner material between the plates and the handle scales. Comes with a pouch made of hippopotamus leather and an attractive gift and storage box.

75 g

No. 709817

5 *Desert Ironwood*

Handle scales made of desert ironwood. Due to its slow growth, desert ironwood from the Arizona desert is one of the hardest and densest wood types. It has a beautiful gold-brown colour with dark streaks. Due to its high density it is extremely resistant to moisture. Comes with a pouch made of ecologically tanned cowhide.

65 g

No. 709811

LE FRANCAIS FOLDING KNIVES

A LE FRANCAIS FOLDING KNIFE
 Inspired by a knife from the 17th century, Perceval developed the model »Le Français«. The blade forged of Sandvik 19C27* steel has been hardened in liquid nitrogen (cryogenic treatment), which makes it extremely durable and easy to sharpen. A smooth liner lock mechanism makes sure the blade is securely locked. The handle back has an open design and

thus accentuates the puristic style. Comes with a pouch made of ecologically tanned cowhide. Hardness 57 HRC, rustproof.

* Steel analysis: C = 0.95 / Si = 0.4 / Mn = 0.65 / Cr = 13.5 (in %)

Blade length 90 mm
 Blade thickness 2.3 mm
 Overall length 200 mm



1 *Serpent Wood*
 Handles scales made of decorative serpent wood. This type of wood, originally from the North American coast, has a brown-yellowish primary colour with irregular brown-black stripes.
 60 g
No. 709803



**Inclusive free sharpening pass.
 For more information see page 4.**



Two free sharpenings



JUNIPER 2

2 Juniper

Handle scales made of juniper. This kind of wood has a brownish colour and a very pleasant peppery scent. In the Middle Ages, this type of wood was popular for smoking purposes, as the smoke was considered to have a cleansing and disinfectant effect.

60 g

No. 709800



EBONY 3

3 Ebony Wood

Handle scales made of elegant black ebony wood, one of the densest and hardest woods in the world.

65 g

No. 709801



MASUR BIRCH 4

4 Masur Birch

Handle scales made of Nordic masur birch wood. This robust type of wood has a very interesting look due to the contrast between the light-coloured heartwood and dramatic dark-coloured rays running through the wood.

60 g

No. 709802



CARBON FIBRE 5

5 Carbon Fibre

Handle scales made of finely structured carbon fibre. Thousands of microscopic carbon fibres are woven with each other and then fused using epoxy resin. This procedure creates an extremely robust material which provides a high tensile and compressive strength despite its low density. These excellent characteristics make it a first-choice material for many industry branches, e.g. in aerospace, mechanical engineering or sporting goods manufacturing.

70 g

No. 709807



SNAKEWOOD 6

6 Snakewood

Handle scales made of richly grained snakewood. This kind of wood is among the world's most precious and hardest wood types. The interesting colouring fascinates with its wavy, scale-like pattern.

65 g

No. 709804



PISTACHIO WOOD 7

7 Pistachio Wood

Handle scales made of French pistachio wood. The attractive chestnut brown colour usually shows decorative darker streaks.

65 g

No. 709808



HORN TIP 8

8 Horn Tip

Handle scales made of Indian Zebu horn. Darker colour shades run through the elegant light ground colour. With black liner material between the plates and the handle scales.

70 g

No. 709805



WACAPOU 9

9 Wacapou

Handle scales made of Wacapou. This kind of wood comes from South Africa and is very hard and resistant. It ranges from light to chocolate brown in colour and shows fine streaks.

65 g

No. 709851



DESERT IRONWOOD 10

10 Desert Ironwood

Handle scales made of desert ironwood. Due to its slow growth, desert ironwood from the Arizona desert is one of the hardest and densest wood types. It has a beautiful gold-brown colour with dark streaks. Due to its high density it is extremely resistant to moisture.

65 g

No. 709806

Handle scales made of natural resources such as wood, horn or bones are **natural products** and may differ in structure or colour - therefore every knife is absolutely unique.

LE GRAND FOLDING KNIVES WITH DAMASCUS BLADES

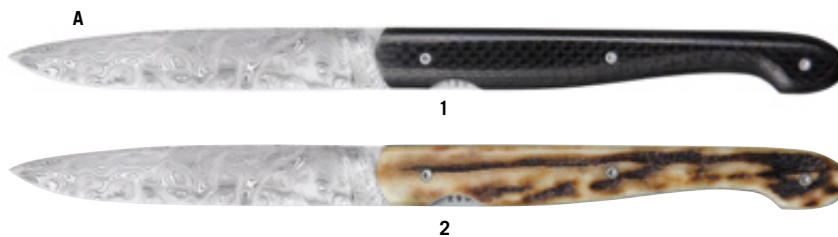

A LE GRAND FOLDING KNIFE
DAMASK

This relatively generously-sized pocket-knife features carefully designed hand-filed patterns at the spring and plates. The powder-metallurgically produced Damasteel Damascus steel blade features a splendid Vinland Damascus structure for a brilliant look. A smooth liner lock mechanism makes sure the ball-bearing fitted blade is securely locked. Comes with a pouch made of ecologically tanned cowhide and in an attractive gift and storage box. Hardness 57 HRC, rustproof.

Blade length 110 mm
Blade thickness 2.3 mm
Overall length 250 mm



**Inclusive free sharpening pass.
For more information see page 4.**



Lifetime sharpening

1 *Carbon Fibre*

Handle scales made of finely structured carbon fibre. Thousands of microscopic carbon fibres are woven with each other and then fused using epoxy resin. This procedure creates an extremely robust material which provides a high tensile and compressive strength despite its low density. These excellent characteristics make it a first-choice material for many industry branches, e.g. in aerospace, mechanical engineering or sporting goods manufacturing. Red liner material between the plates and handle scales.

100 g
No. 709827

2 *Staghorn*

Handle scales made of Indian Sambar staghorn. The material's elegant light ground colour shows darker coloured streaks. Black liner material between the plates and handle scales.

105 g
No. 709828





»LE GRAND« KNIFE
WAS AWARDED THE TITLE
»KNIFE OF THE YEAR 2013«
BY THE READERS OF THE
MAGAZINE »MESSER«.



CLAUDE DOZORME®

The company was founded in 1902 by Blaise Dozorme in Thiers, the »knife capital« of France. This family-run company combines traditional craftsmanship that has been passed down through the years with modern manufacturing technology. Thus, the range includes both traditional folding knives as well as new interpretations of regional knives. Cutlery and flatware complete the product range.



All Le Thiers RLT folding knives come in a wooden box made of oak with a fitting leather pouch.

LE THIERS® RLT FOLDING KNIVES

**A LE THIERS® RLT FOLDING KNIFE**

Special handle materials make each knife in the Le Thiers RLT series unique. With its magnificent structure the rustproof Balbach Damascus steel DSC STAINLESS blade creates an excellent appearance. The blade transition can be adjusted using a small wrench; the blade runs on a ball bearing. A special feature is the extra wide plates on which the handle scales are mounted and fixed with three screws. The lavish ornamentation on the blade spring as well as on the plates is hand filed. Comes in a wooden box made of oak with a leather pouch. Hardness 62 HRC, rustproof. Blade length 90 mm
Blade thickness 2.4 mm
Overall length 210 mm

1 Ram's Horn

Handle scales made of natural ram's horn.
150 g
No. 709678

2 Masur Birch

Handle scales made of Nordic masur birch wood. This robust type of wood has a very interesting look due to the contrast between the light-coloured heartwood and dark-coloured rays running through the wood.
140 g
No. 709757

3 Poplar wood

Handle scales made of stabilised green poplar wood. Damascus steel ferrules provide the transition to the blade and create an excellent visual effect.
150 g
No. 709758

4 Ebony

Handle scales made of elegant, black ebony, one of the world's densest and hardest timbers. The Damascus steel bolsters connect with the blade and produce a truly exquisite look.
140 g
No. 709683

5 Mammoth Molar

Handle scales made of stabilized, coloured mammoth molar. This rare and very fascinating material is about 10 000 years old. The fossil teeth of the Siberian mammoth are won from permafrost zones or glacial ice. Every handle scale has a unique colour. With green liner material between the plates and the handle scales.
160 g
No. 709679



**Inclusive free sharpening pass.
For more information see page 4.**



Lifetime sharpening

LE THIERS® RLT FOLDING KNIVES BANKSIA

Australian banksia cones are used for the handle scales. The natural cavities of the banksia grandis tree's fruit cones are filled with coloured acrylic resin and stabilised. Stabilised materials are extremely resistant, absorb practically no moisture and are therefore very hygienic, washable and do not warp.

The irregularly shaped cones of the banksia grandis tree.



A LE THIERS® RLT FOLDING KNIFE BANKSIA

Named after the French region Thiers, this folding knife fascinates with its elegant design. Stainless steel bolsters finish off the handle and form the join with the polished blade of Swedish Sandvik 14C28N steel. The blade operation can be adjusted using the supplied wrench; the blade runs on a ball bearing. The lavish decoration on the blade spring is hand filed. Rustproof, hardness 58 HRC. Blade length 90 mm
Blade thickness 2.4 mm
Overall length 210 mm
140 g
1 red **No. 708803**
2 white **No. 708804**
3 blue **No. 708805**



1



2



3



B LE THIERS® RLT FOLDING KNIFE DAMASCUS BANKSIA

With its magnificent structure, the rustproof Balbach DSC STAINLESS Damascus steel blade creates an excellent appearance. The blade movement can be adjusted using a small wrench; the blade runs on a ball bearing. A special feature is the extra wide plates on which the handle scales are mounted and fixed with three screws. The lavish decoration on the blade spring is hand filed. Comes in an oak wood box with a leather pouch. Hardness 62 HRC, rustproof. Blade length 90 mm
Blade thickness 2.3 mm
Overall length 210 mm
140 g



1



2



3

1 red **No. 708800**
2 white **No. 708801**
3 blue **No. 708802**





C LE THIERS® RLT FOLDING KNIFE

Named after the French region Thiers, this folding knife fascinates with its elegant design. The handle scales are affixed to stainless steel liners with three screws. Stainless steel bolsters finish off the handle and form the joint with the polished blade of Swedish Sandvik 14C28N steel. The blade operation can be adjusted using the supplied wrench; the blade runs on a ball bearing. The lavish decoration on the blade spring is hand filed. Rustproof, hardness 58 HRC.
 Blade length 90 mm
 Blade thickness 2.4 mm
 Overall length 210 mm
 140 g



1 Thuja
 Handle scales made of vividly grained, red-brown thuja wood.
No. 709734

2 Staghorn
 Handle scales made of staghorn. The material's elegant, light base colour shows darker-coloured streaks.
No. 708809

3 Ebony
 Handle scales made of elegant black ebony, one of the densest and hardest woods in the world.
No. 708808



Inclusive free sharpening pass.
For more information see page 4.

 Two free sharpenings

 Lifetime sharpening



D LE THIERS® DAMASCUS FOLDING KNIFE

Named after the French region Thiers, this folding knife fascinates with its elegant design. Due to its splendid rose Damascus structure, the blade which is made through a powder-metallurgical process creates a beautiful look. A smooth liner lock mechanism makes sure the blade is securely locked. The handle scale on one side is made of light rams horn with a slightly wavy surface. The slim and lightweight knife can be carried comfortably in your pocket. Rustproof, hardness 57 HRC.
 Blade length 70 mm
 Blade thickness 1.9 mm
 Overall length 185 mm
 50 g
No. 709648

All Le Thiers RLT Damascus knives come in a wooden box made of oak with a fitting leather pouch.



LE THIERS® FOLDING KNIVES NATURE



STAG 1



DOG 2



WILD BOAR 3



HARE 4

S **A** LE THIERS® FOLDING KNIVES
Named after the French region Thiers, this folding knife fascinates with its elegant design. An elegant laser engraving decorates the front handle scale made of fine walnut wood. The blade is locked with a liner lock mechanism. Blade of rustproof X50CrMoV15 steel*, hardness 56 HRC.

* Steel analysis: C = 0.5 / Cr = 15 / Mo = 1 / V = 1 (in %)

Blade length 90 mm
Blade thickness 2 mm
Overall length 220 mm
110 g

- 1 Stag
No. 708915
- 2 Dog
No. 708916
- 3 Wild boar
No. 708917
- 4 Hare
No. 708918



LE THIERS® FOLDING KNIVES VERROU



B LE THIERS® VERROU FOLDING KNIVES, DAMASCUS BLADE
With its magnificent structure, the rustproof Balbach DSC STAINLESS Damascus steel blade creates an excellent appearance. The lavish decoration on the blade spring is hand filed. A particular feature of this elegant folding knife is the patented locking mechanism by Claude

Dozorme. A foldable lever on the end of the handle locks the blade both in open and closed positions. Comes in a box. Rustproof, hardness 57 HRC. Blade length 90 mm. Blade thickness 2.2 mm. Overall length 210 mm



1 Ebony
Handle scales made of elegant black ebony, one of the densest and hardest woods in the world.
105 g
No. 708806

2 Masur Birch
Handle scales made of Nordic masur birch wood. This robust type of wood has a very interesting look due to the brown veins and rays running through the wood.
100 g
No. 708807



C LE THIERS® VERROU FOLDING KNIVES
A particular feature of this elegant folding knife is the patented locking mechanism by Claude Dozorme. A foldable lever on the end of the handle locks the blade

both when opened and closed. Blade of rustproof Z50CD15 steel, hardness 58 HRC. Comes in a box. Blade length 80 mm. Blade thickness 2 mm. Overall length 205 mm

1 Ebony
Handle scales made of elegant black ebony, one of the densest and hardest woods in the world.
100 g
No. 709684

2 Stag Motif
Acrylic handle scales with stag motif and staghorn inlay.
110 g
No. 709642



Inclusive free sharpening pass.
For more information see page 4.



Two free sharpenings



Lifetime sharpening





1



2



A LE THIERS® FOLDING KNIFE
 Named after the French region Thiers, this folding knife fascinates with its elegant design. The slim and lightweight knife can be carried in your pocket or attached to your trousers or bag using the robust belt clip. The stainless steel blade (X50CrMoV15*) features a reliable liner lock mechanism. Hardness 56 HRC.

* Steel analysis: C = 0.5 / Cr = 15 / Mo = 1 / V = 1 (in %)

Blade length 70 mm
 Blade thickness 1.8 mm
 Overall length 185 mm
 50 g

1 Buffalo Horn
 Dark buffalo horn handle scale on one side.
No. 709645

2 Olive Wood
 The stainless steel plate handle and blade have a black PTFE coating. The handle scale on one side, made of fine-grained olive wood, make an interesting contrast.
No. 709646



1



2



B LAGUIOLE LINER FOLDING KNIFE
 A modern interpretation of the French knife manufacturing icon - the Laguiole folding knife. Classic plain design and shapes characterize this knife with handle scales on one side and the typical Laguiole blade and handle shapes as well as the »Bee« icon. A reliable liner lock mechanism locks the stainless steel blade (X50CrMoV15*) safely. Robust belt clip on the back. Hardness 56 HRC.

* Steel analysis: C = 0.5 / Cr = 15 / Mo = 1 / V = 1 (in %)

Blade length 85 mm
 Blade thickness 2.2 mm
 Overall length 210 mm

1 Buffalo Horn
 Dark buffalo horn handle scale on one side.
No. 709640

2 Noire, Ram's Horn
 The stainless steel plate handle and blade have a black PTFE coating. The handle scale on one side is made of light ram's horn with a slightly wavy surface.
No. 709641



Integrated corkscrew

C LAGUIOLE FOLDING KNIFE BAROUEUR
 The Baroudeur is a sturdy pocket knife with integrated corkscrew. The blade is locked with a liner lock mechanism. Handles scales made of olive wood with a honey-coloured grain. The wood has excellent material properties and has been appreciated for centuries because of its warm colour. With safety strap and leather hanging loop. Blade of rustproof X50CrMoV15 steel, hardness 54 HRC. Blade length 90 mm
 Blade thickness 2.5 mm
 Overall length 215 mm
 120 g
No. 708846

DOUK-DOUK®

The functional and durable Douk-Douk developed into an icon of knife design in the last century. Originally created in 1928 for the French colonies in Africa and Asia, this knife has been numerous copied but the originals offered here have unmistakable characteristics. The handle scales of folded sheet metal have a convex form so that they sit better in the hand. Embossed with the symbol of the shaman for luck. To avoid injuries, the strong XC48 steel spring can also be latched in the middle position when folding the blade. The blade is decorated with ornamental patterns, hardness 53 HRC. Made by the 4th generation by Pierre Cagnet in the French knife metropolis of Thiers.

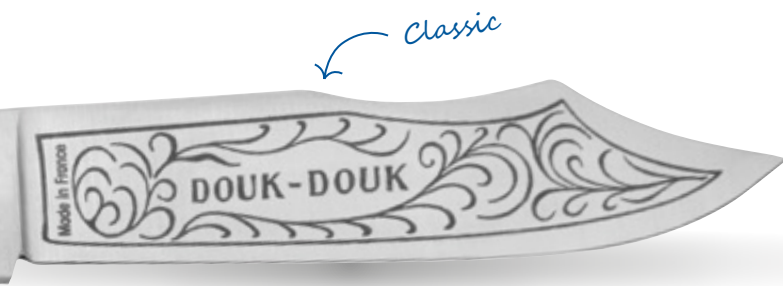

D DOUK-DOUK®
Blade made of XC70 carbon steel, not rustproof. Gunmetal-finished handle.

1 Small
Blade length 65 mm
Blade thickness 2.5 mm
Overall length 160 mm
40 g
No. 709300

2 Large
Blade length 80 mm
Blade thickness 3 mm
Overall length 200 mm
70 g
No. 709301



E DOUK-DOUK®, GREEN
Blade made of rustproof 440A steel. With leather sheath. Handle coated with epoxy resin.

1 Small
Blade length 65 mm
Blade thickness 2.5 mm
Overall length 160 mm
40 g
No. 709500

1 Large
With sharpening steel.
Blade length 80 mm
Blade thickness 3 mm
Overall length 200 mm
70 g
No. 709501



F FOLDING KNIFE SPHÈRE, OLIVE WOOD HANDLE
Practical utility knife with a special locking mechanism - the sphere at the end of the blade snaps into place securely in a recess on the handle. Loosening or tightening the screw on the handle adjusts the smoothness of the folding mechanism. Made in

Thiers, France. Blade made of rustproof Sandvik steel 12C27. Olive wood handle. Comes with case. Hardness 57 HRC.
Blade length 85 mm
Blade thickness 2 mm
Overall length 210 mm
50 g
No. 709238

Inclusive free sharpening pass.
For more information see page 4.

 Two free sharpenings



THE ORIGINAL BY LAGUIOLE EN AUBRAC

The traditional Laguiole en Aubrac forge is one of the most renowned forges in France. The company is located in Espalion, within the »Laguiole Origine Garantie« zone. Each knife is made by a knife smith and is unique because of its handmade components; depending on the design, up to 216 work steps are necessary.



The Laguiole folding knife is an icon of French design. As early as 1829, this knife shape was created in the small mountain village of the same name, Laguiole, in south-west France. The trademarks of this classic knife are the ergonomic shape of blade and handle, the »bee« stop and the fine engraving on the spring. All Laguiole handles have the traditional »Shepherd's cross« made of fine silver ornamental rivets (excluding staghorn handles). Shepherds, who spent the summers with their flocks in the Auvergne highlands, used to stick the blade into the ground and pray in front of the cross. Feather and bee are forged from one piece and artfully decorated by hand (needle etched), each blacksmith having his own engraving.



For a production video see www.dictum.com



A LAGUIOLLE FOLDING KNIFE
 Blade made of easy-to-sharpen, rustproof Sandvik 12C27 steel.
 Hardness 56 HRC.
 Supplied with linen bag.
 Blade length 100 mm
 Blade thickness 2 mm
 Overall length 220 mm

Note: Pay attention to the origin of the knife when buying. Beware of knives manufactured in China or Pakistan, because the name »Laguiolle« cannot be protected. The »LOG« (Laguiolle Origine Garantie) stamp guarantees that the knife originates from the genuine Laguiolle area and is produced using traditional methods.

Handle scales made of natural resources such as wood, horn or bones are **natural products** and may differ in structure or colour - therefore every knife is absolutely unique.



1 Olive Wood
 Handle scales made of olive wood with honey-coloured grain. The wood has excellent material properties and has been appreciated for centuries because of its warm colour.
 80 g
No. 718580



2 Birch
 Handle scales made of masur birch wood. This robust type of wood has a very interesting look due to the contrast between the light-coloured heartwood and dramatic dark-coloured veins radiating through the wood.
 80 g
No. 718582



3 Juniper
 Handle scales made of juniper. This kind of wood has a brownish colour and a very pleasant peppery scent. In the Middle Ages, this type of wood was popular for smoking purposes, as the smoke was considered to have a cleansing, disinfectant effect.
 85 g
No. 718585



4 Walnut
 Handle scales made of fine quality walnut wood.
 80 g
No. 718583



5 Snakewood
 Handle scales made of vividly grained snakewood. This kind of wood is one of the world's most precious and hardest wood types. The interesting colouring fascinates with its wavy, shingle-like pattern.
 85 g
No. 718584



6 Ebony
 Handle scales made of elegant black ebony wood, one of the densest and hardest woods in the world.
 85 g
No. 718581



7 Horn Tip
 Handle scales made of horn. Darker colour shades run through the elegant light ground colour.
 90 g
No. 718586



8 Staghorn
 Handle scales made of staghorn. The material's elegant, light base colour shows darker coloured streaks.
 90 g
No. 718587

Inclusive free sharpening pass.
 For more information see page 4.
 Two free sharpenings



OLIVE WOOD 1



POPLAR BURL WOOD 2



AMBOINA BURL WOOD 3

Mirror-polished ✦



BUFFALO HORN 3

A LAGUIOLLE FOLDING KNIFE WITH DOUBLE PLATE

A real gem with needle etched double plates on the top and bottom. Blade made of easy-to-sharpen, rustproof Sandvik 12C27 steel. Hardness 56 HRC. Supplied in a wooden case. Blade length 100 mm. Blade thickness 2 mm. Overall length 220 mm.

1 Olive Wood

Olive wood has excellent properties and has therefore been regarded as valuable material for many centuries due to its warm colouring and honey-coloured grain of the wood. Stainless steel bolsters and blade satin-finished.

100 g
No. 718589

2 Poplar Burl

Poplar burl wood from roots or burls. Impresses with its extraordinary pattern. Stainless steel bolsters and blade satin-finished.

100 g
No. 718591

3 Amboina Burl

Amboina burl wood, which is produced from trunk or branch outgrowths of the Narra tree, has a reddish brown colour and is distinguished by its individual grain. Stainless steel bolsters and blade satin-finished.

100 g
No. 718592



4 Buffalo Horn

Dark buffalo horn handle scales. Stainless steel bolsters and blade mirror-polished.

105 g
No. 718590

Handle scales made of natural resources such as wood, horn or bones are **natural products** and may differ in structure or colour - therefore every knife is absolutely unique.

B LAGUIOLE FOLDING KNIFE WITH CORKSCREW

Blade made of easy-to-sharpen, rustproof Sandvik 12C27 steel. Hardness 56 HRC. Supplied with linen bag.
Blade length 100 mm
Blade thickness 2 mm
Overall length 220 mm
95 g



1 *Ebony*

Handle scales made of elegant black ebony, one of the densest and hardest woods in the world. Stainless steel bolsters and blade mirror polished.

No. 718588



2 *Oak*

Oak handle scales made from old red wine barrels. Stainless steel bolsters and blade satin-finished.

No. 708811

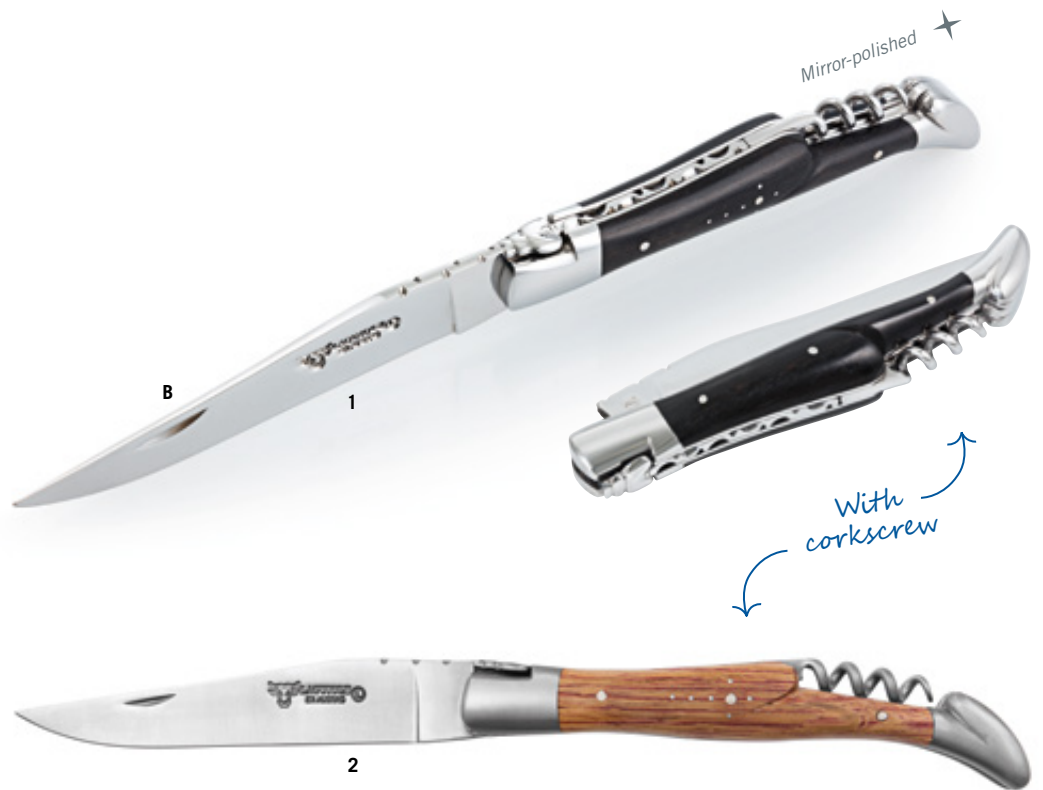

C LAGUIOLE FOLDING KNIFE WITH FORGED SKIN

Blades left with forged skin made of easy-to-sharpen carbon steel XC75, not rustproof, hardened to 54 HRC. Supplied with linen bag.
Blade length 100 mm
Blade thickness 2.5 mm
Overall length 220 mm



1 *Juniper*

Handle scales made of juniper. This kind of wood has a brownish colour and a very pleasant peppery scent. In the Middle Ages, this type of wood was popular for smoking purposes, as the smoke was considered to have a cleansing, disinfectant effect. Stainless steel bolsters and blade mirror-polished.

85 g

No. 718596



2 *Desert Ironwood*

Handle scales made of desert ironwood. Sourced in the deserts of Arizona, the Olneya tree grows at an exceptionally slow pace to produce desert ironwood, one of the world's hardest and densest timbers. The exquisitely beautiful grain shows a golden brown hue with dark streaks. Its high density makes the wood particularly resistant to moisture. Stainless steel bolsters and blade satin-finished.

90 mm g

No. 718595



**Inclusive free sharpening pass.
For more information see page 4.**

 Two free sharpenings

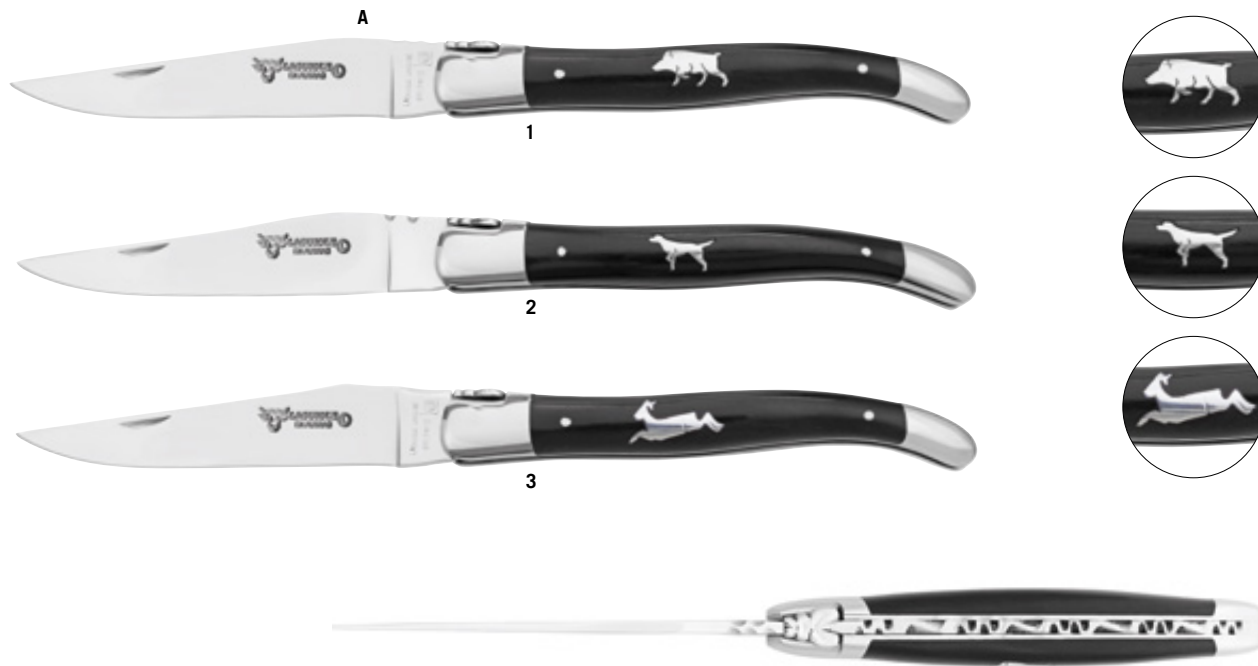

A LAGUIOLE FOLDING KNIFE
INTARSIA
The original by Laguiole en Aubrac:
Handle scales made of elegant black
ebony, one of the densest and hardest
woods in the world. The handle is
decorated with a dog, deer or wild boar
made of pewter (the shepherd's cross
is not included in this model). Blade

made of easy-to-sharpen, rustproof
Sandvik 12C27 steel. Stainless steel
bolsters and blade mirror polished.
Hardness 56 HRC. Supplied with linen
bag.
Blade length 100 mm
Blade thickness 2 mm
Overall length 220 mm
90 g

1 *Wild boar*
No. 708810

2 *Dog*
No. 708847

3 *Roe deer*
No. 708848

Inclusive free sharpening pass.
For more information see page 4.

 Two free sharpenings

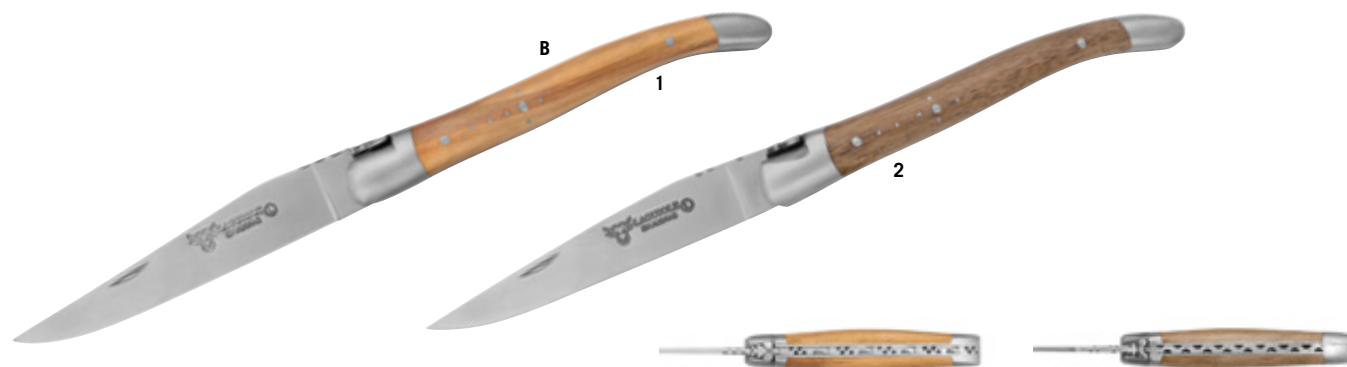

B LAGUIOLE FOLDING KNIFE,
SMALL
Blade made of easy-to-sharpen, rustproof
Sandvik 12C27 steel. Stainless steel bol-
sters and blade satin-finished. Hardness
56 HRC. Supplied with linen bag.
Blade length 85 mm
Blade thickness 2 mm
Overall length 185 mm

1 *Olive Wood*
Handle scales made of olive wood with
honey-coloured grain. The wood has ex-
cellent properties and has therefore been
regarded as a valuable material for many
centuries due to its warm colouring.
No. 718577

2 *Walnut wood*
Handle scales made of fine quality
walnut wood.
No. 718578



C LE RANDONNEUR FOLDING KNIFE

The Randonneur is a simple alternative to the well-known Laguiole knives. A practical folding knife for everyday work, when hiking or for a picnic. Blade made

of easy-to-sharpen, rustproof Sandvik 12C27 steel with slip joint lock. Hardness 56 HRC. Supplied with linen bag. Blade length 100 mm
Blade thickness 2.2 mm
Overall length 220 mm



1 Olive Wood

Handle scales made of olive wood with honey-coloured grain. The wood has excellent properties and has therefore been regarded as a valuable material for many centuries due to its warm colouring.

70 g
No. 718593

2 Wenge

Handle scales made of wenge. The richly contrasting, coarse light/dark structure, usually combined with irregular or interlocked grain, gives wenge its exceptionally decorative character.

65 g
No. 718594



D FOLDING KNIFE D'ICI

Rustic work and utility knife created in cooperation with French designer Auzier. The simple but functional locking mechanism sinks the extended back of the blade into the notch in the handle. Blade of Z40 steel with black forged skin. Rustproof, hardness 54 HRC. Blade length 90 mm
Blade thickness 2.6 mm
Overall length 210 mm

1 Olive Wood

Handle scales made of olive wood with honey-coloured grain. The wood has excellent material properties and has been appreciated for centuries because of its warm colour.

65 g
No. 708812

2 Walnut Wood

Handle scales made of fine quality walnut wood.

60 g
No. 708814

3 Ebony

Handle scales made of elegant black ebony, one of the densest and hardest woods in the world.

65 g
No. 708813



OPINEL



The French company Opinel has been family-owned since it was founded in 1890. Joseph Opinel, then 18, created the first knife in his father's blacksmith's shop and started the remarkable success story. Since its foundation, the company has been based in the Rhône-Alpes region of Savoien. Over 100 employees now ensure that the famous French icon can be found not only in its home country, but all over the world. The symbol of the main couronnée («the crowned hand») was already stamped on the first Opinel knives.

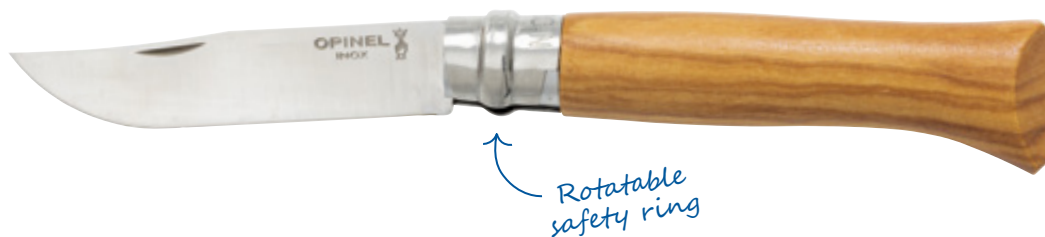

A OPINEL FOLDING KNIFE

French classic:

Blade made of rustproof Sandvik steel 12C27. It can be locked in place at lightning speed by turning a safety ring (Virobloc system). Olive wood handle.
 Blade length
 75 mm (No. 6) / 85 mm (No. 8)
 Blade thickness
 1.2 mm (No. 6) / 1.7 mm (No. 8)
 Overall length
 165 mm (No. 6) / 195 mm (No. 8)

1 Olive, No. 6
 30 g
No. 708281

2 Oak, No. 6
 30 g
No. 708283

3 Walnut, No. 6
 25 g
No. 708285

4 Olive, No. 8
 50 g
No. 708282

5 Oak, No. 8
 45 g
No. 708284

6 Walnut, No. 8
 40 g
No. 708286

B OPINEL FOLDING KNIVES, BEECH

French classic:
Blade made of easy-to-sharpen carbon steel XC90, not rustproof. It can be locked in place at lightning speed by turning a safety ring (Virobloc system). Handle made of beech wood; a special varnish protects against moisture.

No. 6
Blade length 75 mm
Blade thickness 1.2 mm
Overall length 165 mm
30 g
No. 708783

No. 8
Blade length 85 mm
Blade thickness 1.7 mm
Overall length 195 mm
45 g
No. 708784



C OPINEL FOLDING KNIVES, NO. 8, TREKKING

French classic:
Blade made of rustproof Sandvik steel 12C27. It can be locked in place in a flash speed by turning a safety ring (Virobloc system). Beech wood handle, lacquered, with practical leather cord.

Blade length 85 mm
Blade thickness 1.7 mm
Overall length 195 mm
45 g

1 blue **No. 708780**
2 green **No. 708781**

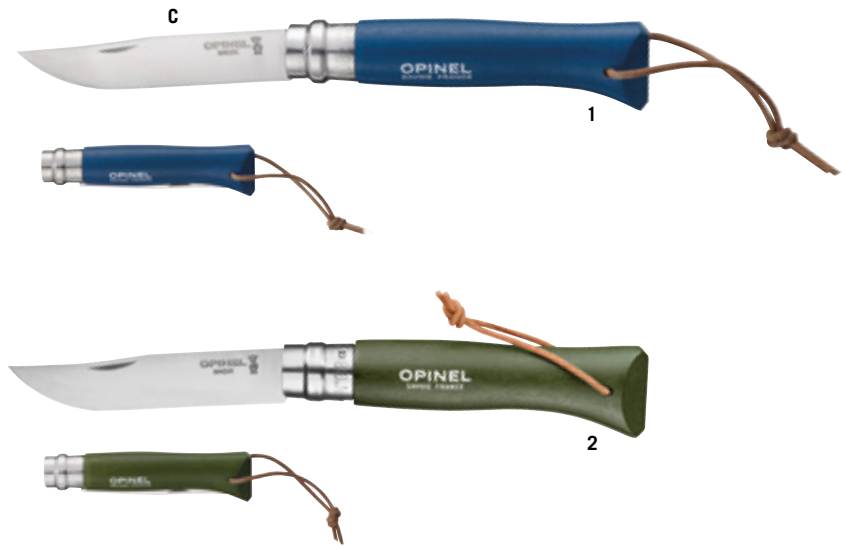

Inclusive free sharpening pass.
For more information see page 4.

 Two free sharpenings



D OPINEL CHILDREN'S KNIFE

French classic:
Blade made of rustproof Sandvik steel 12C27, with rounded tip. It can be locked in place at lightning speed by turning a safety ring (Virobloc system). Beech wood handle.

Blade length 75 mm
Blade thickness 1.5 mm
Overall length 175 mm
35 g

1 nature **No. 708287**
2 blue **No. 708288**
3 pink **No. 708289**



THE DIFFERENCES ARE OBVIOUS TO THE TOUCH

Horn, mother-of-pearl or wood - knives get their individual character from the different handle materials. Horn handles or wooden handles are suitable for everyday use, while mother-of-pearl makes a knife a precious collector's item. None of the natural materials we offer are subject to species conservation (CITES). The respective species are not in danger of extinction. Our animal and vegetable products come from sustainable and managed sources.

LIONSTEEL®

Since 1969, Lionsteel - located in the Italian »knife capital« Maniago - has been primarily producing utility knives, pocket knives and hunting knives in classical clear shapes using exquisite handle materials.



A LIONSTEEL® BESTMAN FOLDING KNIFE, EBONY

Equipped with two different blade shapes, this men's knife is fairly versatile. The clip-point blade has a classic pointed shape. A characteristic feature of the Wharncliffe blade shape is the straight cutting edge with the downward curving tip, which is particularly suitable for drawing cuts. Powder metallurgically produced Böhler M390 steel* is used for the blades. The handle scales are made

of elegant black ebony with titanium bolsters. Rustproof, hardness 61 HRC.

* Steel analysis: C = 1.9 / Si = 0.7 / Mn = 0.3 / Cr = 20 / Mo = 1 / V = 4 / W = 0.6 (in %)

Blade length 70 mm
Blade thickness 2.5 mm
Overall length 240 mm
90 g
No. 709916



B LIONSTEEL® FOLDING KNIFE TS1 DAMASCUS

The entire handle, including the frame-lock of the TiSpine, is machined from a solid block of titanium (Ti-6Al4V) and is completely decorated with a fine groove pattern using ultra-modern CNC manufacturing technology. The blade made of Chad Nichols »Fate« damascus steel manufactured of rustproof AEB-L and 304 steel, creates an excellent aesthetic

appearance. The handle fits comfortably in the hand. Furthermore, the groove structure is not only decorative - it also improves the grip. Robert Young Pelton designed this knife. Hardness 58 HRC, rustproof.

Blade length 80 mm
Blade thickness 3 mm
Overall length 195 mm
100 g
No. 709674

Inclusive free sharpening pass.
For more information see page 4.



Two free sharpenings



Lifetime sharpening



C LIONSTEEL® FOLDING KNIFE SR-1 DAMASCUS

The entire handle, including the frame-lock, is machined from a solid block of titanium (Ti6Al4V) and is decorated with a fine groove pattern using ultra-modern CNC manufacturing technology. The groove pattern is not only decorative - it also improves the grip and allows the knife to fit comfortably in the hand. The precious blade made of Chad Nichols

»Raindrop« damascus steel, manufactured of rustproof AEB-L and 304 steel, creates an excellent appearance. In addition, the knife has a rotoblock safety. Simply rotate the safety wheel a little bit to lock the open blade. The belt clip can be mounted on the right or left, or even completely removed, thanks to the enclosed key. The screw for fixing the clip also serves as a glass breaker. The integral design by Michele »Molletta«

Pensato offers the highest stability with appealing aesthetics. Supplied with wooden case made of Mogano wood which fits the knife exactly. Hardness 58 HRC, rustproof.
Blade length 95 mm
Blade thickness 4.5 mm
Overall length 210 mm
190 g
No. 709675



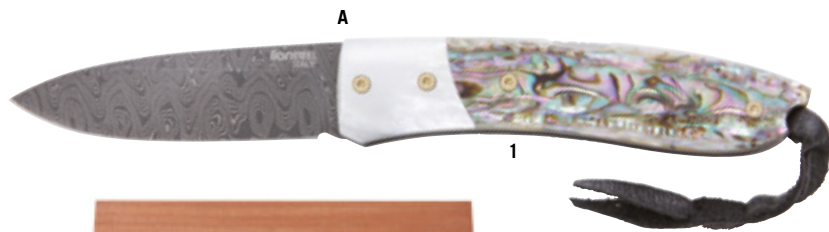

A

1

A LIONSTEEL® FOLDING KNIFE OPERA »DAMASCUS«
 The precious blade made of 200-layered Chad Nichols Damascus steel »Scrambled«, manufactured of rustproof AEB-L and 304 steel, creates an excellent appearance. A back lock mechanism securely locks the blade of the handy knives. Delivery with wooden case made of Mogano wood which fits the knife exactly. Hardness 58 HRC, rustproof. Blade length 75 mm
 Blade thickness 2.8 mm
 Overall length 175 mm

 **1 Mother-of-Pearl**
 Mother-of-pearl fascinates with an adorable glossiness and intriguing array of colours since known to humankind. The white coloured mother-of-pearl is harvested from the saltwater pearl (pinctada maxima). Paua is harvested from a mussel species (haliotis iris) from the South Seas which is characterized by a highly figured and colourful grain (blue/turquoise/green and pink).
 80 g
No. 709328



2



 **2 Olive Wood**
 Olive wood has excellent properties and has therefore been regarded as valuable material for many centuries due to its warm colouring and honey-coloured grain of the wood.
 65 g
No. 709323

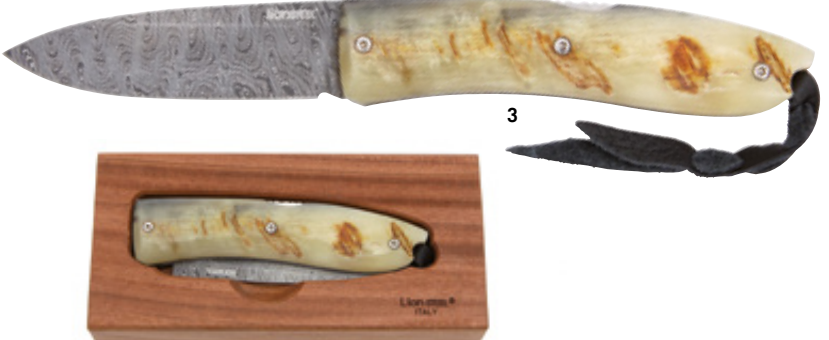

3

 **3 Ram's Horn**
 Handle scales made of dark ram's horn with a slightly structured surface.
 75 g
No. 709670



Inclusive free sharpening pass. For more information see page 4.
 Two free sharpenings
 Lifetime sharpening



B

 **B LIONSTEEL® FOLDING KNIFE MINI »DAMASCUS«, RAM'S HORN**
 The precious blade made of 200-layered Chad Nichols »Scrambled« Damascus steel, manufactured from rustproof AEB-L and 304 steel, looks impressive. The handle scales made of natural ram's horn are also an eye-catcher. A liner lock mechanism securely locks the blade of the handy companion. The handle back has an open design. Comes with wooden case made of Mogano which fits the knife exactly. Hardness 58 HRC, rustproof. Blade length 60 mm
 Blade thickness 2 mm
 Overall length 145 mm
 60 g
No. 709673

C LIONSTEEL® FOLDING KNIFE
OPERA, OLIVE

The product line »Opera« has been designed in cooperation with »Max Design«, a well-known Italian artisan. First class utility knife with back lock mechanism, olive wood handle. The handy knife has a hanging eyelet with twisted leather string. Delivery with leather belt pouch. Blade made of wear-resistant D2 steel with a hardness of 59 HRC.

Blade length 75 mm
Blade thickness 2.8 mm
Overall length 175 mm
75 g

No. 709320



D LIONSTEEL® FOLDING KNIFE
MINI, OLIVE

The handy knives in the »mini« series fit into any pocket. The blade is made of D2 steel with an outstanding edge life, and is held in place by a reliable liner lock mechanism. The handle back has an open design and the knife also features a hanging eyelet fitted with a braided leather band. Not rustproof, hardness 60 HRC.

Blade length 60 mm
Blade thickness 2 mm
Overall length 145 mm
50 g

No. 709671



MERCURY®



Mercury, founded in 1950, has its headquarters in the well-known Italian »knife capital« Maniago. Originally, the company specialised in the complex production of multifunctional pocket knives. Meanwhile, the product range includes a large selection of folding knife models as well as hunting and outdoor knives with fixed blades.

E MERCURY® MULTITOOL
STAGHORN

Multi-purpose pocket knife with robust staghorn handle scales and stainless steel bolsters. In order to save some weight, the liners are made of »Anticorodal«, a light aluminium alloy. The knife has the following functions:

- Blade made of rustproof 420 steel, hardness 55 HRC
- Saw
- Bottle opener with integrated slotted screwdriver
- Scissors
- Corkscrew
- Can opener
- Fork
- Piercing awl/reamer

Blade length 70 mm
Blade thickness 1.8 mm
Overall length 170 mm
130 g

No. 708830



F MERCURY® FOLDING KNIFE
STAGHORN

Rugged folding knife with staghorn handle scales and stainless steel bolsters. The rustproof Z50CD15 steel blade is locked by a back lock mechanism. Hardness 57 HRC.

Blade length 70 mm
Blade thickness 3 mm
Overall length 180 mm
115 g

No. 708829



MASSIMO SALICE SANNA

What started out as a hobby in 1993 quickly became a passion for Massimo Salice Sanna, or Max for short. Accurate workmanship and attention to detail are what characterise this avid knife maker. All the steps are performed exclusively by hand, from the tempering of the steel to the elaborate grinding work and ornamentation. In his workshop in Italy, he composes small works of art from the best steels and most precious woods.



A FOLDING KNIFE DAGHETTA

This knife is completely hand-made and features a high-quality finish as well as an extraordinary choice of blade steel and exquisite wood for the handle scales. The knife maker used Vanadis 10* steel for the knife blade. The well-balanced composition of the high vanadium alloyed tool steel, which is made using a powder metallurgy process, provides good toughness and very high resistance to wear, which makes it particularly well-suited for high-per-

formance tools. A thumb pin, which is set with a burl wood inlay, makes it easy to open. The blade is securely locked thanks to the smooth liner lock mechanism. The plate is made of titanium**. The hand-filed ornamentation on the titanium** back spring and part of the blade spine, which also serves as a thumb rest, make this knife a real eye-catcher. The aesthetic grain of the handle scales made of ash burl wood is especially pleasing. Comes with a leather pouch, stainless steel, hardness

64 HRC.

* Steel analysis: C = 2.9 / Si = 0.5 / Mn = 0.5 / Cr = 8 / Mo = 1.5 / V = 9.8 (in %)

Blade length 85 mm
Blade thickness 1.1 mm
Overall length 200 mm
120 g
No. 709870

**Titanium is a lightweight, very durable, completely rustproof, anti-magnetic and hypo-allergenic metal. At a similar tensile strength, it is about one-third lighter than steel.

**Inclusive free sharpening pass.
For more information see page 4.**



Lifetime sharpening



**B FOLDING KNIFE WORKER**

Exceptional, entirely handmade folding knife made of Damasteel. Damasteel, manufactured in Sweden, is a stainless Damascus steel produced using powder metallurgy out of RWL34* (»light«-coloured) and PMC27** (»dark«-coloured) steel by sintering and forging. The combination of these two special steels produces not only a magnificent pattern, but also the best material properties. A smooth frame-lock mechanism makes sure the blade is securely locked in place. With this system, the movable liner for the blade lock is an integral part of the self-supporting handle. The elaborate guillochage on the blade spring and spine, which also serves as a thumb rest, makes this a real eye-catcher. This

artful ornamentation is filed by hand. Comes with a leather pouch, rustproof, hardness 59 HRC.

* Steel analysis RWL34: C = 1.05 / Si = 0.5 / Mn = 0.5 / P = 0.05 / S = 0.03 / Cr = 14 / Mo = 4 / V = 0.2 (in %)

** Steel analysis PMC27: C = 0.6 / Si = 0.5 / Mn = 0.5 / Cr = 13 (in %)

Blade length 65 mm
Blade thickness 2.8 mm
Overall length 155 mm
90 g

No. 709871

**C FOLDING KNIFE GOBLIN**

Handmade one-of-a-kind knife with handle scales made of mammoth tusk. This rare and fascinating material tells a story that is up to 10 000 years old. The fossil tusks of the Siberian mammoth are obtained from permafrost ground or glacial ice. The colouring of each handle scale is unique, as the originally cream-coloured tusks have discoloured to different extents after lying in permafrost for millennia. Damasteel is used for the blade, a type of rustproof Damascus steel produced in Sweden using powder metallurgy via the sintering and forging of the steel types RWL34* (»light« patterns) and PMC27** (»dark« patterns). The combination of these two special types of steel creates not only an impressive pattern, but also the best material properties. Locking the blade is done with a smooth liner lock mechanism, and the blank is made of titanium***. The hand-

filed ornamentation on the titanium*** back spring is particularly eye-catching. Comes with leather case, rustproof, hardness 60 HRC.

* Steel analysis RWL34: C = 1.05 / Si = 0.5 / Mn = 0.5 / P = 0.05 / S = 0.03 / Cr = 14 / Mo = 4 / V = 0.2 (in %)

** Steel analysis PMC27: C = 0.6 / Si = 0.5 / Mn = 0.5 / Cr = 13 (in %)

Blade length 70 mm
Blade thickness 3 mm
Overall length 165 mm
90 g

No. 709872



***Titanium is a lightweight, very durable, completely rustproof, anti-magnetic and hypo-allergenic metal. At a similar tensile strength, it is about one-third lighter than steel.



The Maserin head office is based in the Italian »knife making capital Maniago«, where authentic folding and hunting knives have been made since 1960. Together with renowned Italian knife makers and designers, new innovative models are being developed all the time. Combined with high-value handle materials, they create aesthetic utility knives of excellent quality.



A MASERIN® GOURMET FOLDING KNIFE

Gourmet series pocket knives are ideal and stylish companions in everyday life. A reliable liner lock mechanism holds the rustproof blade made of AUS-8 steel firmly in place. The handle cheeks are mounted on stainless steel plates. A wood inlay seals the back of the handle, underscoring the knife's elegant look. This design was produced in cooperation with Attilio Morotti, an Italian knife maker. Comes with a leather pouch, hardness 58 HRC.
Blade length 100 mm
Blade thickness 2.6 mm
Overall length 220 mm

1 Olive Wood
Handle scales made of olive wood with honey-coloured grain. The wood has excellent properties and has therefore been regarded as a valuable material for many centuries due to its warm colouring.
85 g
No. 709665

2 Bocote
Handle scales made of grained bocote wood. The decorative hardwood from South America is of a light brown colour with dark brown veins.
85 g
No. 709663

3 Ebony
Handle scales made of elegant black ebony, one of the densest and hardest woods in the world.
90 g
No. 709664

Burlwood
Handle scales made of stabilised maple root wood with interesting grain. Stabilised wood is extremely resistant, absorbs practically no moisture and is therefore very hygienic.
85 g

- 4 Blue No. 709833**
- 5 Black No. 709834**
- 6 Green No. 709835**
- 7 Brown No. 709836**



Inclusive free sharpening pass. For more information see page 4.
 Two free sharpenings

**B MASERIN® »SESSANTESIMO«
FOLDING KNIFE**

Maserin celebrates its 60th anniversary. The Sessantesimo slip joint folding knife series has been reissued in memory of the first models produced in the 1960s. These light, handy folding knives fit in every trouser pocket and are perfect for on-the-go. The knife consists of a main blade and a smaller saw cut blade made of rustproof 420 steel. Supplied with leather case. Rustproof, hardness 56 HRC.
Blade length 60 mm
Blade thickness 1.8 mm
Overall length 200 mm
40 g

Micarta

Micarta is produced in a special high-pressure process by combining an absorbent carrier material (cellulose, linen, etc.) with epoxy resin. The material is almost indestructible and resistant to acids and oils.

- 1 blue **No. 709845**
- 2 brown **No. 709846**



3 Carbon

Anodised aluminium handle with carbon and gold-plated screws. Thousands of microscopic carbon fibres are woven with each other and then fused using epoxy resin. This procedure creates an extremely robust material which provides a high tensile and compressive strength despite its low density. Sturdy leather case with clip.

No. 709847



← saw cut blade



↗ Gold-plated screws

**C MASERIN® »IN-ESTRO«
FOLDING KNIFE**

This design was created in cooperation with Alessandro Olivetto, an Italian knife maker. The knife has a satin-finished sheepfoot blade made of cut-resistant D2 steel. This blade shape is ideal for straight, precise cuts. The handle scales have inlays of either olive or bocote wood, framed in jaws of anodised aluminium. Removable belt clip. With strap hole, rust-resistant blade, hardness 58 HRC.

Blade length 70 mm
Blade thickness 2.2 mm
Overall length 185 mm
65 g

1 Olive Wood

Handle scales made of olive wood with a honey-coloured grain. The wood has excellent material properties and has been appreciated for centuries because of its warm colour.

No. 709848

2 Bocote

Handle scales made of grained Bocote wood. The decorative hardwood from South America has a light brown base colour with dark brown veins.

No. 709849



MASERIN® FOLDING KNIFE SCOUT

 Pocket knife in a classic shape made of modern materials. The stonewash-finished blade of rust-resistant D2 steel is characterised by an excellent edge-holding capacity and sharpness.

Handle with thong hole. Rust-resistant, hardness 60 HRC.
Blade length 80 mm
Blade thickness 2 mm
Overall length 185 mm

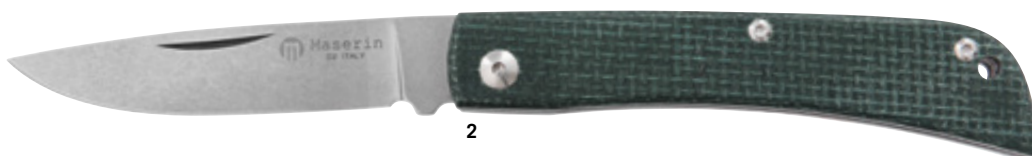

A Olive Wood

Handle scales made of olive wood with honey-coloured grain. The wood has excellent material properties and has been appreciated for centuries because of its warm colour.

65 g
No. 708837

B Micarta

Micarta is produced in a special high-pressure process by combining an absorbent carrier material (cellulose, linen, etc.) with epoxy resin. The material is almost indestructible and resistant to acids and oils.

- 75 g
- 1 black No. 708838
 - 2 green No. 708839
 - 3 grey No. 708840
 - 4 red No. 708841



C MASERIN® FOLDING KNIFE CONSOLI

Playful elegance:

This gentleman knife was designed in cooperation with knife maker Sergio Consoli. The result is a precisely manufactured jackknife, created for everyday use. The stainless steel plates feature eye-catching ornamental patterns, whose attractive wave patterns extend across the entire handle. This outline continues along the fluted back spring and on to the back of the blade, where it serves additionally as a thumb rest. The darkly stained handle scales made of stabilised bruyère wood beautifully complete the knife's extraordinary look. A back lock mechanism holds the blade firmly in place. The blade is made of rustproof Böhler-N690 steel that offers superb cutting properties. Comes with a leather pouch.

Blade length 75 mm
Blade thickness 3 mm
Overall length 175 mm
85 g

No. 709668



D MASERIN® FOLDING KNIFE

This satin-finish blade of wear-resistant D2 steel is locked with a liner lock mechanism. The bolsters are made of structured G10. This high-quality fibreglass composite, which is manufactured using a special high-pressure process in combination with epoxy resin, is very hard and resistant. The belt clip is removable. With thong hole, rust-resistant blade, hardness 60 HRC.

Blade length 80 mm
Blade thickness 2 mm
Overall length 195 mm

1 Carbon Fibre

Handle scales made of finely structured carbon fibre. Thousands of microscopic carbon fibres are woven with each other and then fused using epoxy resin. This procedure creates an extremely robust material which provides a high tensile and compressive strength despite its low density.

85 g

No. 709696

2 Olive Wood

Handle scales made of olive wood with honey-coloured grain. The wood has excellent properties and has therefore been regarded as a valuable material for many centuries due to its warm colouring.

90 g

No. 709837



E MASERIN® FOLDING KNIFE ARNO

This elegant jackknife was produced in cooperation with French designer Jean Marc Arnaud. Its blade is made of rustproof 440C steel; it is opened using the thumb stud. A reliable liner lock mechanism holds the blade firmly in place. The handle scales are made of elegant black ebony, which is one of the world's densest and hardest woods.

The front third of the handle's back is left open, while the rear part is sealed using an ornamental inlay made of rustproof stainless steel. Hardness 56 HRC, rustproof. Comes with a leather pouch.

Blade length 70 mm
Blade thickness 2.7 mm
Overall length 165 mm
75 g

No. 709669



Inclusive free sharpening pass.
For more information see page 4.



Two free sharpenings



A MASERIN® FOLDING KNIFE OLIVE WOOD

This hefty folding knife with sturdy handle scales made of finely grained olive wood is completed by large stainless steel bolsters. The back lock mechanism securely locks the blade of rustproof 440B steel. With thong hole, hardness 56 HRC.

Blade length 75 mm
Blade thickness 2.7 mm
Overall length 190 mm
150 g
No. 709340



B MASERIN® MUSHROOM KNIFE

The perfect companion for picking mushrooms:

The rustproof steel blade is slightly curved to cut the mushrooms precisely, and it can be folded securely to store and transport it. The serrated back of the blade adds extra stability and can also be used to remove larger pieces of residue, e. g. soil. The brush with wild boar bristles helps you clean the mushrooms. The walnut wood handle is provided with a tape measure (5 cm scale) and a pair of tweezers is integrated into the handle. Chain with snaplink. Rustproof 420 steel, hardness 56 HRC.

Blade length 70 mm
Blade thickness 2 mm
Overall length 210 mm
90 g
No. 709503



C MASERIN® FOLDING HUNTING KNIFE, 3-PIECE SET, STAG HORN

A practical companion for hunting. With its sturdy handle scales and a stainless steel ferrule, this 3-piece folding hunting knife features the following:

- Knife that is locked securely with a back lock mechanism; blade of rust-proof 440C steel, hardness 56 HRC
- Saw for small branches or bones
- Gutting blade

Blade length 70 mm
Blade thickness 2.7 mm
Overall length 175 mm
175 g
No. 709504



D MASERIN® FOLDING KNIFE G10

The satin-finished 440C steel blade is locked by a liner lock mechanism. Handle made of structured G10. This high-quality glass fibre-plastic composite is produced in a special high-pressure process with epoxy resin. It is very hard and resistant. Removable belt clip. Rust-proof, hardness 58 HRC.

Blade length 75 mm
Blade thickness 3 mm
Overall length 170 mm
90 g
No. 709759

Inclusive free sharpening pass. For more information see page 4.
 Two free sharpenings



TECNOCUT



Like most major Italian knife manufacturers, the company Tecnocut is based in the »knife capital« of Maniago. Tecnocut has been constantly developing and producing new knife models under the brand name Viper since it was founded in 1987.



E VIPER® FOLDING KNIVES SLIM

This small folding knife could almost be confused with a piece of jewelry. The handle is decorated with a dog, stag or wild boar made of 825 silver. The pocket knife is locked with a frame lock mechanism. With belt clip. Blade of rustproof Sandvik steel 12C27. Comes in box. Hardness 55-57 HRC. Blade length 50 mm. Blade thickness 2 mm. Overall length 120 mm. 45 g.



1 *Dog*
No. 709922

2 *Wild boar*
No. 709924

3 *Stag*
No. 709923



F VIPER® FOLDING KNIFE QUALITY, RAM'S HORN

This classic gentlemen's pocket knife was designed by Fabrizio Silvestrelli, a member of the Italian Knifemakers' Guild. The hammered titanium jaws perfectly match the handle scales. The handle back is set with four small finger grips. The handle form makes the knife easy to handle. The knife also does not have any edges, as all the components have been rounded. Comes with leather pouch. The polished blade made of rustproof Böhler-N690 steel is securely locked in place with the back lock mechanism, hardness 57-59 HRC. Handle scales made of light-coloured, slightly textured ram's horn. Blade length 75 mm. Blade thickness 3 mm. Overall length 180 mm. 115 g.



No. 709876



G VIPER® FOLDING KNIFE TIMELESS

As the name suggests, the name »Timeless« stands for its ageless design. This elegant folding knife is the result of a cooperation with Fabrizio Silvestrelli, a member of the Italian Knifemakers' Guild. The satin-finished blade is crafted from rustproof Sandvik 12C27 steel, and held in place by a liner lock mechanism. Its handle scales are an accomplished combination of elegant ebony and distressed titanium bolsters. The slightly rounded, edgeless handle makes the



knife very comfortable in the hand. It is delivered in a leather sheath. Hardened to 55-57 HRC, rustproof. Blade length 70 mm. Blade thickness 2.5 mm. Overall length 165 mm. 90 g.

No. 709877





A VIPER® FOLDING KNIVES KEY
 Modern, slim gentleman's pocket knife, designed by Jesper Voxnaes. The rounded blade spring is elaborately decorated by hand. Satin-finish blade made of powder-metallurgical Böhler M390 steel. Comes in a leather sheath. Rustproof, hardness 61 HRC.
 Blade length 80 mm
 Blade thickness 2.7 mm
 185 mm



Inclusive free sharpening pass. For more information see page 4.

Two free sharpenings

1 Bronze carbon
 The handle scales, made of bronze carbon fibres, are mounted on titanium plates and titanium jaws. Thousands of microscopic carbon fibres are woven with each other and then fused using epoxy resin. This procedure creates an extremely robust material which provides a high tensile and compressive strength despite its low density.
No. 708817

Titanium
 The handle scales made of 6AL4V titanium are decorated with a fine, 3D-milled groove pattern. Titanium is a light, extremely robust, totally rustproof, anti-magnetic and anti-allergic metal. It features a similar tensile strength as steel, but is around a third lighter.

2 Titanium No. 708815
3 Blue titanium No. 708816



B VIPER® FOLDING KNIVES BERGAMASCO
 Traditional folding knife from the Lombardy region, named after the city of Bergamo. Rustproof, satin-finish Böhler-N690 steel blade. The patented Action Stopper System is used as the slip joint mechanism. The blade is stopped by two detent balls, but not locked. Limited edition of 1000 pieces. Comes with leather bag. Rustproof, hardness 55-57 HRC.
 Blade length 80 mm
 Blade thickness 3 mm
 Overall length 200 mm
 100 g



1 Boxwood
 Handle scales made of elegant, light boxwood, one of the densest and hardest woods in Europe.
No. 708820

2 Horn Tip
 Handle scales made of horn. Darker colour shades run through the elegant light base colour.
No. 708821

C VIPER® KLAPPMESSER DAN1
 In cooperation with designer Tommaso Rumici, Viper has created the DAN (Daily Assorted Needs), a modern, everyday pocket knife. There are different handle materials to choose from; in the rear part of the handle there is a connecting piece made of titanium. The blade has no locking mechanism, but the Action Stopper system allows two detent balls to engage the blade in three positions, thus preventing unintentional opening or closing. With removable and repositionable belt clip. Rustproof Böhler-N690 steel, hardness 59 HRC.
 Blade length 75 mm
 Blade thickness 3 mm
 Overall length 180 mm



1 Olive Wood
 Handle scales made of olive wood with honey-coloured grain. The wood has excellent properties and has therefore been regarded as a valuable material for many centuries due to its warm colouring.
 85 g
No. 709925

2 Zircote wood
 Handle scales made of attractively grained zircote wood.
 85 g
No. 709926

3 G10
 Handle scales made of lightly structured green G10, a high-quality fibreglass composite produced in a special high-pressure process combined with epoxy resin. The material is very hard and resistant.
 100 g
No. 709928

4 Carbon
 Carbon fibre handle scales. Thousands of microscopic carbon fibres are woven with each other and then fused using epoxy resin. This procedure creates an

extremely robust material which provides a high tensile and compressive strength despite its low density.
 90 g
No. 709927



D VIPER® FOLDING KNIFE RASOLINO
 Characteristic of this traditional Sicilian folding knife is the shape of the blade, which is based on a razor and gives the knife its name. It evolved in Sicily in



the middle of the 18th century when it was forbidden to carry knives with pointed blades. Rustproof blade made of durable X50CrMoV15 steel* (1.4116). The patented Action Stopper system is used as slip joint mechanism. The blade is stopped by two detent balls, but not locked. Limited edition of 1000 pieces. Supplied with leather bag. Rustproof, hardness 55-57 HRC.

* Steel analysis: C = 0.5 / Si = 1 / Mn = 1 / Cr = 15 / Mo = 0.8 / V = 0.2 (in %)

Blade length 80 mm
 Blade thickness 3 mm
 Overall length 200 mm



1 Olive Wood
 Handle scales made of olive wood with honey-coloured grain. The wood has excellent properties and has therefore been regarded as valuable material for many centuries due to its warm colouring.
 80 g
No. 709913

2 Zircote wood
 Handle scales made of attractively grained zircote wood.
 85 g
No. 709914

3 Horn Tip
 Handle scales made of horn. Darker colour shades run through the elegant light base colour.
 90 g
No. 709915





Nieto

The history of Nieto goes back to 1957, when Miguel and Inocencio Nieto helped their father in his small knife production. In 1980, Miguel Nieto founded his own company and since then has been producing high-quality and reliable knives under the brand name »M. Nieto« in Albacete, Spain.

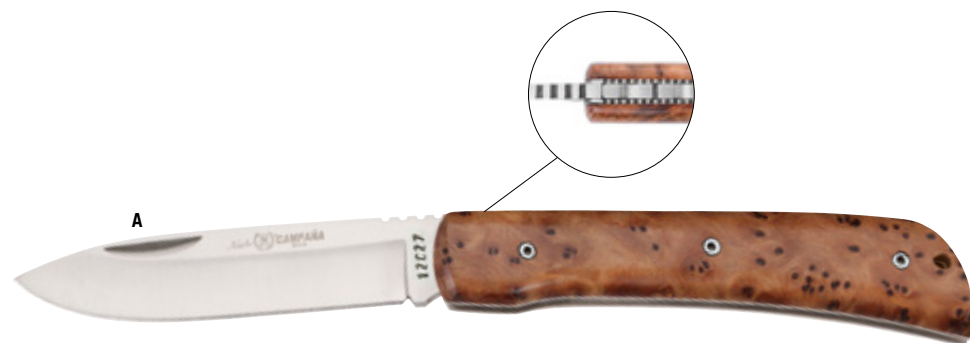

A NIETO POCKET KNIFE CAMPANA

With the Campana series, the Spanish manufacturer Nieto presents a traditional pocket knife. The robust blade of rustproof Sandvik steel 14C28N is held in position by a strong back spring with decorative filework. Handle scales made of vividly grained, red-brown thuja wood. Supplied with safety strap. Rustproof, hardness 59 HRC.
Blade length 90 mm
Blade thickness 3.5 mm
Overall length 200 mm
105 g
No. 708791



B NIETO POCKET KNIFE CENTAURO

Traditional, handy pocket knife with satin-finished blade made of high-quality Böhler N-695 steel. When open, the blade is reliably locked by a back lock mechanism. The ergonomic handle is composed of stainless steel plates, an intermediate layer of red fibreglass and neatly adapted handle scales. Supplied with safety strap, rustproof, hardness 60 HRC.
Blade length 75 mm
Blade thickness 2,7 mm
Overall length 185 mm

1 G10
Handle scales made of G10 material. G10 is a high-quality fibreglass composite produced in a special high-pressure process combined with epoxy resin. The material is very hard and resistant.
120 g
No. 708798

2 Bocote
Handle scales made of grained bocote wood. The decorative hardwood from South America is of a light brown colour with dark brown veins.
110 g
No. 708793

MKM MANIAGO KNIFE MAKERS

Behind MKM (Maniago Knife Makers) are four well-known Italian knife manufacturers: Viper, Lionsteel, Mercury and Fox Knives. They create interesting, distinctively designed knife models in cooperation with well-known knife designers.



C MKM® FARA FOLDING KNIFE

This modern slip joint pocket knife has been created in cooperation with custom knife maker Lucas Burnley. The blue anodised titanium ring around the blade's axial screw as well as the long nail mark and the safety strap eyelet set special accents. Blade made of powder-metallurgical Böhler M390 steel. Comes with leather pouch with belt loop. Rustproof, hardness 59 HRC.
Blade length 75 mm
Blade thickness 2.5 mm
Overall length 180 mm

1 Aluminium
Handle scales made of black anodised aluminium.
65 g
No. 708825

2 Olive Wood
Handle scales made of olive wood with honey-coloured grain. The wood has excellent material properties and has been appreciated for centuries because of its warm colour.
70 g
No. 708826

3 Titanium
Handle scales made of 6AL 4V titanium. Titanium is a light, extremely robust, totally rustproof, anti-magnetic and anti-allergic metal. It possesses a similar tensile strength as steel, but is around a third lighter.
90 g
No. 708824

Inclusive free sharpening pass. For more information see page 4.

 Two free sharpenings

S D MINI DAMASCUS FOLDING KNIFE
 This sample of a fascinating Damascus blade is created by 32 lateral layers of stainless steel and a cutting layer made of Japanese VG-10 steel. The blade of this handy knife is held in place with a back lock mechanism. Each handle scale has a unique colour. Made in the USA. Rustproof, hardness 60 HRC.
 Blade length 50 mm
 Blade thickness 2 mm
 Overall length 135 mm
 50 / 55 g



1 Beech
 Handle scales made of stabilised spalted beech wood with intensive pattern caused by spalting. During the stabilisation process, the wood is completely impregnated with a specially developed acrylic resin, using a vacuum pressure procedure. By means of this procedure, it becomes highly robust and absorbs practically no moisture, making it highly hygienic, washable, and warp-free. One handle scale is inlaid with turquoise precious stones.
No. 719668

2 Mammoth molar
 Handle scales made of mammoth molar. This rare, fascinating material tells a story that is up to 10 000 years old. These fossilised teeth from Siberian mammoths are obtained from permafrost soil or glacial ice. With precious stone inlay made of jet and mother-of-pearl, edged with nickel silver.
No. 719669



3 Mammoth tusk/stone
 This model uses two different handle scales. One handle scale is a combination of mammoth tusk, set in nickel silver strips and dark black jet (gemstone). The stone, mined in the southwest of the USA, is also known as »black amber«. The fossil tusks of the mammoth are obtained from permafrost soil or glacial ice. Due to thousands of years of storage in permafrost, the originally cream-coloured teeth have become individually discoloured. The other handle scale is made of dyed, stabilised birch wood.
No. 708794

4 Mammoth bone
 This model uses two different handle scales. One handle scale is made of stabilised mammoth bone. In the stabilisation process, the bones are completely impregnated with a specially developed acrylic resin using a vacuum pressure process. Stabilised materials are extremely resistant, absorb practically no moisture and are therefore very hygienic, washable and do not warp. The other handle scale is made of dyed, stabilised birch wood.
No. 708795

SMITH & SONS



Smith & Sons is a young and up-and-coming family-run knife company headquartered in Louisiana, USA. It has been producing excellent quality handmade utility knives for hunting, outdoor and leisure activities since 2011. All knives come with sturdy tanned leather sheaths.



S E CYPRESS TRAPPER FOLDING KNIFE
 This model is based on the Trapper folding knife, a classic and one of the oldest models among the American pocket knife formats. The blade is made of rust-resistant D2 steel, which is known for its excellent edge retention and sharpness. Phosphor bronze washers ensure easy action and a liner lock mechanism holds the blade securely in place. Robust, removable belt clip. Not rustproof, hardness 60 HRC.
 Blade length 80 mm
 Blade thickness 3 mm
 Overall length 195 mm

1 G10
 Handle scales made of lightly structured G10, a high-quality fibreglass composite produced in a special high-pressure process combined with epoxy resin. The material is very hard and resistant.
 125 g
1 black No. 709852
2 green No. 709854

3 Micarta, brown
 Micarta is produced in a special high-pressure process by combining an absorbent carrier material (cellulose, linen, etc.) with epoxy resin. The material is almost indestructible and resistant to acids and oils.
 115 g
No. 709853

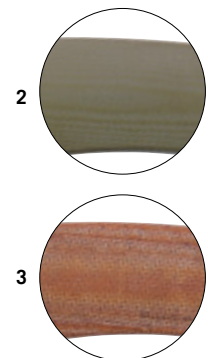

MERCATOR®



This folding knife is an icon of German knife design and has been produced almost unchanged since the era of Emperor Wilhelm II. Light and compact (only 7 mm thick) but almost indestructible, it is a reliable companion for all outdoor activities. The hand guard offers a high level of safety, even under the hardest use (e.g. carving). Handle with hanging loop. Carbon steel achieves ultimate sharpness and is easy to sharpen, the blade must be regularly oiled. Rustproof steel is easy to care for, however, due to the high chromium content, it is not as easy to sharpen.

Lightweight, compact and very flat



A MERCATOR® POCKET KNIVES

Blade length 85 mm
Blade thickness 2.2 mm
Overall length 200 mm
75-80 g

Carbon Steel Blade
Carbon steel C75 blade with back lock stop.

- Handle material
- 1** Copper **No. 709779**
 - 2** Brass **No. 709775**
 - 3** Sheet Steel **No. 709168**
 - 5** Wood Insert, Walnut Wood **No. 709785**
 - 6** Wood Insert, Smoked Oak **No. 709787**

Rustproof Blade
Rustproof blade (X46Cr13 steel) with back lock stop.

- Handle material
- 1** Copper **No. 709780**
 - 2** Brass **No. 709776**
 - 3** Sheet Steel **No. 709772**
 - 4** Stainless Steel **No. 709783**
 - 5** Wood Insert, Walnut Wood **No. 709786**
 - 6** Wood Insert, Smoked Oak **No. 709788**



B *Carbon Steel Blade, Clip*
Carbon steel C75 blade with back lock stop. Removable belt clip.

- Handle material
- 3** Sheet Steel **No. 709781**

B *Rustproof Blade, Clip*
Rustproof X46Cr13 steel blade with back lock stop. Removable belt clip.

- Handle material
- 3** Sheet Steel **No. 709782**
 - 4** Stainless Steel **No. 709784**

► For 70 mm blade length versions see www.dictum.com



Seit 1840 scharfe Qualität aus Solingen.

HIPPEKNIEP FOLDING KNIFE

The Hippekniep (Hippe = goat; Kniep = fold in) is a versatile, robust pocket knife. In the past it was used as a working knife in agriculture. Stable workmanship and selected handle woods give these slip joint knives their special charm. The blade is made of easy-to-sharpen, non-rustproof carbon steel C75, hardness 57 HRC.

C SMALL

Blade length 70 mm
Blade thickness 1.9 mm
Overall length 165 mm
55 g

D LARGE

Blade length 90 mm
Blade thickness 2.5 mm
Overall length 200 mm
100 g



1 Eisbuche®

Eisbuche® is beech wood with an attractive grain refined by a special icing process. Brass blanks and rivets.

Small **No. 710040**
Large **No. 710043**



2 Plum

Plum wood has a very intensive reddish to violet-brown hue with a fine, even structure. Brass blanks and rivets.

Small **No. 710041**
Large **No. 710044**

3 Smoked Oak

Smoked oak is oak wood, elegantly darkened by smoking. Stainless steel blanks and rivets.

Small **No. 710042**
Large **No. 710045**



Inclusive free sharpening pass.
For more information see page 4.

 Two free sharpenings



JAMES

THE JAMES BRAND®



E THE JAMES BRAND® FOLSOM FOLDING KNIFE

Compact, practical pocket knife for everyday use. The blade made of American Carpenter CTS BD1 steel* is held in place with a liner lock mechanism. The removable clip can be mounted on both sides. Comes in a wooden box with a precisely milled fit and felt pouch. With thong hole. Hardness 59 HRC, double bevel, rustproof. Handle scales made of black, slightly

textured G10. The material is extremely hard and robust, and the textured surface gives it a slip-resistant feel.

* Steel analysis: C = 0.9 / Si = 0.37 / Mn = 0.6 / Cr = 15.5 / Mo = 0.3 / V = 0.1 (in %)

Blade length 70 mm
Blade thickness 2.5 mm
Overall length 170 mm
95 g
No. 708264





A THE JAMES BRAND® CHAPTER FOLDING KNIFE

Modern materials, modest elegance, and functionality characterise this folding knife. The handle frame is made of 6AL 4V titanium, and the D2 steel blade is outstanding at holding an edge and extremely sharp. Titanium is a light, highly robust, entirely rustproof, anti-magnetic and anti-allergic metal, and is a third lighter than steel despite possessing similar tensile strength. A smooth frame lock mechanism holds the blade securely in place. In this locking mechanism, the mobile liner for the blade lock is an integral component of the self-supporting handle. Removable belt clip. Comes in a wooden box with a precisely milled fit. Double bevel. Rust-resistant.
 Blade length 65 mm
 Blade thickness 2.8 mm
 Overall length 160 mm
 75 g

1 Titan
 Hardness 60 HRC.
No. 709794

2 Black
 Blade and handle frame with PVD coating. Hardness 56 HRC.
No. 709793



B THE JAMES BRAND® FOLDING KNIFE COUNTY, EBONY

Handy, modern knife with an elegant, slim design. The sophisticated combination of wood and rustproof steel for the handle creates a timeless design. Rustproof 12C27 Sandvik steel is used for the blade, which provides a good compromise between holding an edge and easy sharpening. Comes in a wooden box with a precisely milled fit and felt pouch. Double bevel, rustproof.
 Blade length 60 mm
 Blade thickness 2.6 mm
 Overall length 150 mm
 55 g
No. 709795



C THE JAMES BRAND® ELKO FOLDING KNIFE

Worn on a key ring, this knife is your constant companion for on-the-go. Rustproof Sandvik steel 12C27 is used for the blade, which provides a good compromise between wear-resistance and ease of sharpening. Handle scales made of anodised aluminium.



The hanging loop at the end of the handle doubles as a screwdriver. Hardened to 58 HRC, double bevel, rustproof.
 Blade length 40 mm
 Blade thickness 2 mm
 Overall length 110 mm
 25 g

1 black No. 708260
2 champagne No. 708797
3 green No. 708262
4 black/black No. 708263

SVÖRD™



At the age of 18, master cutler Brian Baker started to establish his company Svörd Knives in New Zealand back in 1983. The rustic-style working and utility knives »Peasant« feature a simple but effective locking mechanism, which allows to slide the longer back of the blade into the notch on the handle. Two brass screws enable the individual adjustment of the locking mechanism. The blades are made of Swedish carbon steel (Sandvik 15N20), which ensures an extremely long edge life. The black forged skin on the rear part of the blade emphasizes the rustic look of the knife. Not rustproof.

D SVÖRD™ FOLDING KNIFE PEASANT

A rustic working and utility knife with a simple but effective locking mechanism. The elongated back of the blade slides into the notch on the handle. The robust plastic handle has two brass screws for individual adjustment of the locking mechanism. The blade is made of Swedish carbon steel, which ensures an extremely long edge life. Not rustproof.

1 *red*

With robust red plastic handle.
Blade length 80 mm
Blade thickness 2 mm
Overall length 210 mm
75 g
No. 709333

2 *black*

With robust black plastic handle.
Blade length 80 mm
Blade thickness 2 mm
Overall length 210 mm
75 g
No. 709334



1



2



► For a Svörd Folding Knife Kit see www.dictum.com

E



E SVÖRD™ LEATHER CASE PEASANT, BROWN

Leather pouch with belt loop, fits Svörd Peasant folding knives No. 709333 and 709334.
No. 709335

F SVÖRD™ FOLDING KNIFE PEASANT MICRO

The Peasant Micro is a compact pocket knife that is a perfect companion for small cutting tasks. Comes with a leather pouch.
Blade length 50 mm
Blade thickness 1.8 mm
Overall length 125 mm
45 g



1 *Copper*

No. 709697

2 *Brass*

No. 709698



1



2



Inclusive free sharpening pass.
For more information see page 4.



Two free sharpenings

SWIZA POCKET KNIVES



The Swiss company SWIZA can already look back on more than a hundred years of tradition as a watch manufacturer. Since 2015, modern multi-function knives have also been produced at the Delémont site in the Swiss Jura. A special feature of the Swiza knives is the liner lock mechanism, which is not available on classic army knives.

With their slightly curved shape, the tools are easily accessible and, thanks to the continuous cut-outs, easy to open for right- and left-handed users. The blade is locked by a liner lock mechanism and the blade can be folded back in again by pressing the Swiss cross integrated in the handle.

A SWIZA® POCKET KNIFE D03
The knife has the following functions:

- Blade made of rustproof 440-A steel, hardness 57 HRC
- Punch awl/reamer
- Sewing awl
- Wire bender
- Bottle opener
- Screwdriver no. 3
- Can opener
- Screwdriver no. 1
- Tweezers with bevelled tip
- Sommelier cork screw with 5 turns

The ergonomically shaped knife handle is equipped with a hard-wearing anti-slip surface. The combination of plastic and stainless steel makes the knives durable and easy to clean.

Blade length 75 mm
Blade thickness 1.6 mm
Overall length 165 mm
85 g
No. 709905

B SWIZA® CHILDREN'S POCKET KNIFE

The SWIZA children's pocket knife has the following functions:

- Blade with rounded tip of rustproof 440-A steel, hardness 57 HRC
- Punch awl/reamer
- Sewing awl
- Phillips screwdriver no. 1-3
- Tweezers with rounded tip

The ergonomically shaped knife handle is equipped with a hard-wearing anti-slip surface. The combination of plastic and stainless steel makes the knives durable and easy to clean.

Blade length 75 mm
Blade thickness 1.6 mm
Overall length 165 mm
65 g
No. 709908

C SWIZA® POCKET KNIFE TICK TOOL

The SWIZA TICK TOOL is a must-have for every pet owner and adventurer. With the newly developed tick tool made of plastic, ticks can be easily and completely removed from the skin. After the tick has been removed, the bite can be checked with the integrated magnifying glass. The knife has the following functions:

- Blade made of rustproof 440-A steel, hardness 57 HRC
- Saw
- Punch awl/reamer
- Sewing awl
- Bottle opener
- Screwdriver no. 3

- Wire bender
- Tick tool with magnifying glass
- Tweezers with bevelled tip
- Sommelier cork screw with 5 turns

The ergonomically shaped knife handle is equipped with a hard-wearing anti-slip surface. The combination of plastic and stainless steel makes the knives durable and easy to clean.

Blade length 75 mm
Blade thickness 1.6 mm
Overall length 165 mm
105 g
No. 709906

D SWIZA® POCKET KNIFE D07
The knife has the following functions:

- Blade made of rustproof 440-A steel, hardness 57 HRC
- Scissors
- Punch awl/reamer
- Sewing awl
- Wire bender
- Bottle opener
- Screwdriver no. 3
- Can opener
- Screwdriver no. 1
- Tweezers with bevelled tip
- Sommelier cork screw with 5 turns

The ergonomically shaped knife handle is equipped with a hard-wearing anti-slip surface. The combination of plastic and stainless steel makes the knives durable and easy to clean.

Blade length 75 mm
Blade thickness 1.5 mm
Overall length 165 mm
110 g
No. 709909

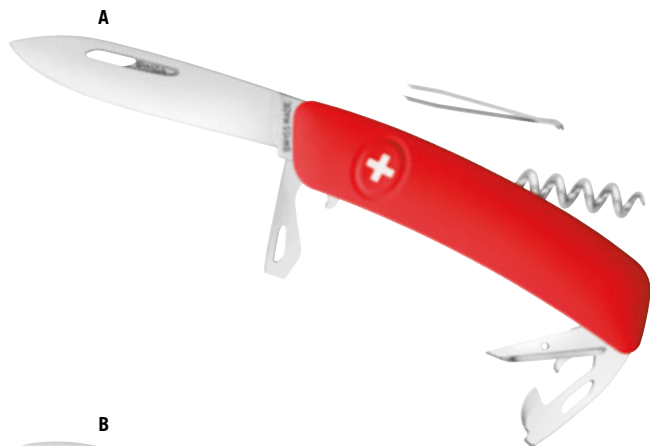

Incl. tick tool with magnifying glass

E SWIZA® POCKET KNIFE D03 BLACK
 The completely black knife is coated with a highly resistant, deep black high-tech coating of polytetrafluoroethylene (PTFE). The knife has the following functions:

- Blade made of rustproof 440-A steel, hardness 57 HRC
- Punch awl/reamer
- Sewing awl
- Wire bender
- Bottle opener
- Screwdriver no. 3
- Can opener
- Screwdriver no. 1
- Tweezers with bevelled tip
- Sommelier cork screw with 5 turns

The ergonomically shaped knife handle is equipped with a hard-wearing anti-slip surface. The combination of plastic and stainless steel makes the knives durable and easy to clean.

Blade length 75 mm
 Blade thickness 1.6 mm
 Overall length 165 mm
 85 g
No. 709907



Inclusive free sharpening pass.
For more information see page 4.



Two free sharpenings

F SWIZA® POCKET KNIFE TICK TOOL

The SWIZA Tick Tool is a must-have for every pet owner and adventurer. With the newly developed tick tool made of plastic, ticks can be easily and completely removed from the skin. After the tick has been removed, the bite can be checked with the integrated magnifying glass. The knife has the following functions:

- Blade of rustproof 440-A steel, hardness 57 HRC
- Saw
- Punch awl/reamer
- Sewing awl
- Bottle opener
- Screwdriver no. 3
- Wire bender
- Tick tool with magnifying glass
- Tweezers with bevelled tip
- Sommelier cork screw with 5 turns

Blade length 75 mm
 Blade thickness 1.6 mm
 Overall length 165 mm
 80 g

1 Olive Wood

Handle scales made of olive wood with honey-coloured grain. The wood has excellent material properties and has been appreciated for centuries because of its warm colour.

No. 708690

2 Walnut wood

Handle scales made of fine quality walnut wood.

No. 708691



Incl. tick tool 



Incl. tick tool 





A **OBSIDIAN KNIFE BY SUEMORI**
 Unique pieces:
 The Hokkaido-based knife maker Tokashi Suemori learned the archaic art of fracturing obsidian from the Ainu, an ancient tribe in the north of Japan. We

are occasionally able to offer examples of his work, with each piece having a unique form. The price lies between €280-490 depending on the size and form of the knife.
No. 716247



B **KNIFE PENDANT WITH LEATHER SHEATH**
 Hand-forged and fully functional: This beautiful knife made of carbon steel (61 HRC) is completely handcrafted. Its ancient design makes it very attractive and it is also fully functional. The dark scaled surface of the metal provides a

nice contrast to the light brown leather sheath, made of high quality, vegetable-tanned Vachetta leather that is soft to the touch and absolutely skin-friendly.
 Overall length 95 mm
 30 g
No. 719707



C **TRATTENBACHER FOLDING POCKET KNIFE**
 The Löschenkohl factory in Trattenbach is a relic and meanwhile a classic of the once blooming foundry industry in Upper Austria. The folding pocket knives have been ideal bread knives since the 16th century, but hobbyists, hikers and craftsmen alike can also appreciate these

rustic folding knives. Original shape, with turned beech handle and wide, roof-shaped blade. Rustproof blade, hardness 50 HRC, simple finish.
 Blade length 75 mm
 Blade thickness 1.5 mm
 Overall length 175 mm
 30 g
No. 719149



VICTORINOX

D **VICTORINOX® FOLDING KNIFE**
 Functional and elegant: traditional Swiss pocket knife with handle scales made from elegant, robust walnut wood. Depending on the model, the knives are equipped with 10 or 13 tools. Rustproof.
 Blade length 70 mm
 Blade thickness 1.8 mm
 Overall length 160 mm

1 Spartan Wood, 10-Piece Set
 Tools: large blade / small blade / can opener / screwdriver 3 mm / bottle opener / screwdriver 6 mm / wire stripper / reamer, punch and sewing awl / cork-screw / key ring
 60 g
No. 709798

2 Huntsman Wood, 13-Piece Set
 Tools: large blade / small blade / can opener / screwdriver 3 mm / bottle opener / screwdriver 6 mm / wire stripper / reamer, punch and sewing awl / cork-screw / scissors / wood saw / multi-purpose hook / key ring
 100 g
No. 709799

Inclusive free sharpening pass.
 For more information see page 4.

 Two free sharpenings

SHARPENING

How to sharpen a dull cutting edge is a matter of some debate amongst experts, and their opinions often lie far apart from each other. We recommend the technique proven over centuries for the sharpest of all cutting edges, the Samurai sword: Manual sharpening on waterstones.

This method, which is suitable for both knives and tools, will be here introduced along with a wealth of tips and tricks from our sharpening experts.

What is sharpness? Sharpness is defined by the quality of the intersection of the two bevels which meet at the cutting edge. Dull blades show a rounding at the cutting edge. Sharpening is therefore concerned with the precise abrasion of material on the bevelled surfaces in order to obtain a perfect cutting edge again.

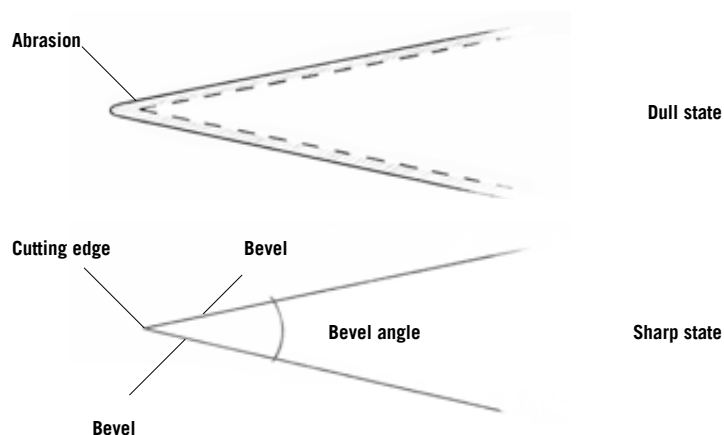

www.perfect-sharpening.com

Everything about SHARPENING TECHNIQUES, TOOLS AND KNOWLEDGE

Useful tips and tricks and step-by-step instructions for sharpening knives and tools with the appropriate sharpening devices.

- Sharpening techniques by hand on waterstones and on machines
- Videos and video tutorials
- Sharpening Primer
- Sharpening courses
- Sharpening professionals answer your questions
- Professional sharpening service



Vide 

Scan now and discover optimised contents for desktop, tablet or smartphone!



www.perfect-sharpening.com

SHARPENING WITH BENCH STONES

Waterstones

Water acts as a rinsing medium which prevents the pores of the stones from clogging with abrasion debris and preserves its abrasion qualities. If the stone is not often enough rinsed with water, the abrasion debris forms a paste-like slurry that reduces the abrasive effect. Professional sharpeners make use of this principle to achieve a finer abrasion in order to compensate greater grit differences. The stones must be soaked in water for 10-15 minutes before use. Ceramic stones like Shapton stones hardly absorb water. With them, 1 minute of soaking is enough.

Sharpening

For sharpening knives, a waterstone with a grit size of about 1000 (e.g. No. 711008) should be used first. Soak the stone in water for a few minutes before placing it on a slip-proof surface (e.g. No. 705364).

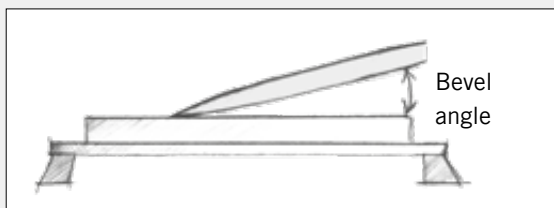

Handling the knife

Position the knife blade diagonally on top of the stone at an angle as close to the recommended angle as possible.

While maintaining the desired angle, use straight movements to grind the blade lengthwise on the stone, and be sure to use the stone's entire surface. Use your right hand to hold the knife's handle and rest your right index finger on the blade. The fingertips of your left hand should be spread close to the cutting edge and used to exert pressure.

TIP: When guiding the knife, keep your fingertips away from the stone's surface to avoid scraping the skin and causing a painful injury.



Honing

The term honing refers to the process used to remove the burr created during sharpening. Before beginning, rinse the blade to remove the particle remains of the prior stone. For honing, use a stone with a minimum grit size of 4000.



Handling the knife

Place the blade lengthwise onto the stone and grind it in the direction of the cutting edge. At this stage, the blade can be held at a slightly steeper angle (1°-2°) than that used for grinding to ensure the burr is removed completely. As a rule, a few light strokes are required on each bevelled edge in alteration before the burr can no longer be felt with the fingertips.

TIP: With increasing delicacy, reduce the amount of pressure placed on the blade - too much pressure

will distort the finely ground cutting edge. When finished, rinse the knife thoroughly in warm water. Carbon steel blades should be treated with a little oil to prevent rust.

► For sharpening tutorials see www.perfect-sharpening.com



honing. You can feel it with your fingertip if you run your finger over the bevel away from the cutting edge, applying slight pressure.

Control during the sharpening process

If you rinse with water regularly during the sharpening process, the stone has its highest efficiency. Some paste like slurry will build up if you rinse less. This polishing paste may be welcome to smooth out the grit steps between the different stones. In order to see how the blade and the stone are interacting, look at the sharpening tracks on the wet surface of the stone. A balanced and rhythmic sound is another good sign that the blade is being sharpened evenly.

Sharpening on coarse or medium-grit stones creates a visible burr, which is later removed during



Single-bevel knives



Japanese knives with a bevel on only one side of the blade are slightly hollow-ground on the back side. For this reason, only the cutting edge and the back of the blade should touch the sharpening stone when laid flat. Only the bevelled side should be sharpened, but both the bevelled and back sides should be honed. During honing, the entire surface of the blade can rest on the stone, whereas the surface of the sharpening stone must be absolutely flat.



Double-bevel knives

Standard, double-bevel knives require sharpening on both sides. After the entire length of one side has been sharpened, turn the knife over and sharpen the opposite side. Either the handle is now held in the left hand, as shown in the picture, or you turn around the knife while holding it in your right hand (now the cutting edge faces you and your thumb rests on the blade). For blades that are simply dull from use, not damaged, about 20-30 strokes per side should be enough.



Sharpening the tip

To sharpen the tip of a knife, raise the handle until only the front of the blade touches the stone. Using one or two fingers, press the tip down and grind it lengthwise on the stone using a straight sharpening motion.



Damaged blades

Damaged cutting edges and broken tips are not reasons to discard much-loved knives. Finely ground, very hard Japanese knives in particular can suffer an occasional nick when handled roughly. Place the blade perpendicular to the stone and grind the entire length of the cutting edge down to the damaged spot. The bevel can now be ground onto each side of the blade in the desired angle using coarse-grit followed by fine-grit stones.

King®/Sun Tiger®

Matsunaga is one of the largest manufacturers of sharpening stones in Japan. In the West, these stones are usually known as King stones or Sun Tiger stones. The stones of the King or Sun Tiger series have a relatively soft bond, which allows the abrasives to be continually exposed during use, making the stone highly effective. These stones are particularly suitable for extremely hard, **low-alloy carbon steels** (White and Blue Paper Steel). Before use, soak the stones in water for at least 15 minutes. They can also be stored in water permanently. Green silicon carbide abrasive is used for 180 grit. For all other grits aluminium oxide is used.



A KING® SHARPENING STONE, GRIT 800
207 x 66 x 34 mm
No. 711001



B KING® HONING STONE, GRIT 4000
210 x 73 x 22 mm
No. 711021



C SUN TIGER®/KING®, GRIT 1000/6000
150 x 50 x 25 mm
No. 711007

Sharpening Stones

Medium-grit stones for sharpening blunt edges.

A KING® SHARPENING STONE, GRIT 800
207 x 66 x 34 mm
No. 711001

KING® SHARPENING STONE, GRIT 1000
207 x 66 x 34 mm
No. 711011

KING® SHARPENING STONE, GRIT 1200
207 x 66 x 34 mm
No. 711002

Honing Stones

Fine-grit waterstones for removing the burr, polishing and honing.

B KING® HONING STONE, GRIT 4000
210 x 73 x 22 mm
No. 711021

KING® HONING STONE, GRIT 6000
185 x 62 x 19 mm
No. 711003

KING® HONING STONE »GOLD«, GRIT 8000
185 x 62 x 19 mm
No. 711004

Combination Stones

With two different grits.

C SUN TIGER®/KING®, GRIT 1000/6000
150 x 50 x 25 mm
No. 711007

205 x 50 x 25 mm
No. 711005

207 x 66 x 36 mm
No. 711006



D TOGERU® SHARPENING DEVICE
For keeping the correct angle when sharpening knives manually. Simply put on the back of the blade - when sharpening, place the incorporated ceramic fence on the honing stone surface. In this way, the bevel angle is quickly determined and warping movements are avoided. Suitable for double-bevelled knives.
Max. blade width 30-50 mm
Max. blade thickness 3 mm
No. 705377



Kunsuto® Sharpening Stone Series

This stone series was developed in cooperation with a Japanese sharpening stone expert. The aim was to create a Japanese stone series suitable for both **high-alloy tool steels and low-alloy carbon steels**. The numerous tests were supported by microscopic images of the cutting edges after sharpening. This stone series has a medium-hard bond, which does not wear out quickly even with tool steels made of alloy components with a coarse grain structure (e.g. chromium and vanadium). However, both steel types allow good material removal with a pleasant ease of use. The microscopic images show a harmonious surface and a precise cutting edge form for both types of steel. Before use, soak the stone for at least 10 minutes. Do not keep it in water permanently.

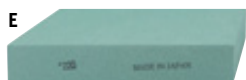

E KUNSUOTO® SHAPING STONE
Coarse-grained stone for material removal, repairs, removing nicks, correcting the grinding angle, removing corrosion. Green silicon carbide abrasive.
Grit 220
205 x 78 x 35 mm
No. 711230



F KUNSUOTO® SHARPENING STONES
Stones with medium sized grit for sharpening blunt blades. Abrasive: #600 aluminium oxide, #1000 aluminium oxide and white aluminium oxide, #3000 white aluminium oxide.
205 x 78 x 25 mm
Grit
600 **No. 711231**
1000 **No. 711232**
3000 **No. 711233**



G KUNSUOTO® HONING STONES
Fine grain water stones for removing the burr, polishing and honing. White aluminium oxide abrasive.
205 x 78 x 35 mm
Grit
6000 **No. 711234**
8000 **No. 711235**
10 000 **No. 711236**



H KUNSUOTO® COMBINATION STONES
This stone features two different grit sizes. Abrasive: #1000 aluminium oxide and white aluminium oxide, # 3000 and 6000 white aluminium oxide.

Grit 1000/3000
For sharpening.
205 x 75 x 35 mm
No. 711237

Grit 1000/6000
For sharpening and honing.
205 x 75 x 35 mm
No. 711238

3-Piece Set Price advantage
Set consists of sharpening stones with grits 600 (No. 711231), 1000 (No. 711232) and 3000 (No. 711233). It is ideal for sharpening cutting tool edges
No. 711248



I DMT® NON-SKID MAT
Prevents sharpening stone slippage.
100 x 250 mm
No. 705364



J ANTI-SLIP BLOCKS, 2-PIECE SET
Non-slip rubber base for sharpening stones. Length of stone support area: 70 mm per side.
93 x 87 x 15 mm
No. 711102



K SHARPENING STONE HOLDER
• All metal parts made of stainless steel
• Anti-slip rubber clamping jaws
• Mid-mounted support bracket for thin stones
Jaw opening 135-220 mm
Width 70 mm
Support height 23 mm
No. 711101

Pride Abrasive® Inc.

Pride Abrasive Inc. is an American sharpening stone manufacturer based in Bristol, Wisconsin. Since 1978, the company has been producing high-quality industrial abrasives such as honing stones for bearing seating and joint surfaces.

L PRIDE ABRASIVE® SHARPENING STONES

Specially designed for modern tool steels with a high carbon content (e.g. O1) and **exotic steel alloys (PM steels)** produced by premium tool makers. The tests that we performed on this stone series show unbeatable results, especially with HSS. The stone contains mainly extremely abrasion-resistant aluminum oxides made in Germany. It removes material quickly and has a hard bond, so it stays flat for a long time. Before use, soak the stone for at least 15 minutes. Can be permanently stored in water. Made in USA.

203 x 76 x 25 mm

Grit

1	220	No. 727482
2	400	No. 727483
3	600	No. 727484
4	800	No. 727485
5	1000	No. 727486
6	3000	No. 727487
7	6000	No. 727488
8	8000	No. 727489
9	10 000	No. 727490

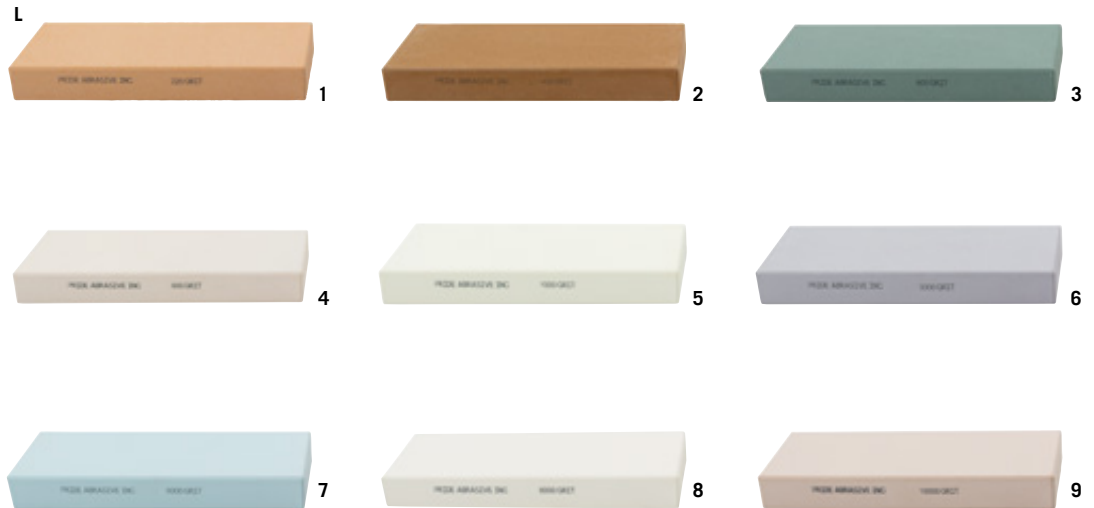

Vide  on Pride Abrasive® sharpening stones available online.

M PRIDE ABRASIVE® COMBINATION STONE 1000/6000
203 x 76 x 25 mm
No. 714168



► For more Pride Abrasive® Combination Stones see www.dictum.com

Glass Stones by Shapton®

The premium range from Japanese company Shapton is the »Glass Stone« series. The sharpening particles are highly pure and homogeneous. This is noticeable when changing to finer grits: the traces from the previous grit are quickly ground out. A special bond allows quick sharpening on a flat surface. The sharpening stone has a base of tempered glass and is thus 100 % warp-free. Conventional sharpening stones may warp at the microstructure level by absorbing water, but Shapton stones solve this problem with their extremely flat base of tempered glass. Another advantage of the glass base is that the grit rating on the underside is always visible even after long use. Before use, spray the stones with water. It is not recommended to keep them in water permanently. White aluminium oxide abrasive.

Vide  on the Shapton Glass Stone Set »Seven« available online.



N SHAPTON® GLASS STONE SET »SEVEN« HR

Aesthetic - highly functional - in a class of its own:
According to the motto »the beauty of the usefulness«, Shapton has again managed to combine the subject of sharpening and the fascination of sharp blades into a natural unit. Plus, the simple, almost artistic product becomes a design object that can be kept effortlessly clean thanks to the high-quality materials.

The set contains:

- 3 compact sharpening stones (HR, 160 x 37 x 12 mm, **for high-alloy tool steels**) with grit sequence tailored to kitchen knives
- Anti-slip stone holder made of easy-to-clean glass
- Ultra-flat diamond truing plate (flatness tolerance of ± 0.005 mm) for truing the sharpening stones

Grit 500 (25 micron),
2000 (6.7 micron),
approx. 16 000 (0.44 micron)
No. 711624



Sharpening Sets

Sharpening Sets for Selective Application

Each cutting tool needs to be sharpened differently, depending on its design or purpose. However, opinions vary as to the best method and abrasives to use. With our sets, we aim to provide you with the basic equipment necessary for all common tools, with detailed sharpening instructions and photos.

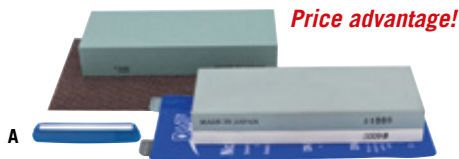

A SHARPENING SET FOR KNIVES OF HIGH-ALLOY STEELS VG-10, PM STEELS, 440 C, SKD 11
This set contains a Kunsuto 220 grit shaping stone (No. 711230) for repairing nicks and a Kunsuto 1000/6000 grit combination stone (No. 711238) for sharpening and honing. Use the trueing

Price advantage!
grille (No. 711297) for trueing the stones, the non-skid mat (No. 705364) keeps the stones in place. Also included is a Togeru sharpening device (No. 705377), which helps maintain the correct angle when sharpening knives.
No. 711240



B BASIC SHARPENING SET FOR ALL TOOLS
This set provides you with a combination of sharpening stones for most tools (e.g. chisels, plane blades, knives). It contains a Sun Tiger 220 grit coarse shaping stone (No. 711010) for pre-sharpening, King 800 grit and 1200 grit sharpening

stones (No. 711001 and 711002) for sharpening, plus a King 4000 grit stone (No. 711021) and a polishing stone 8000 grit (No. 711084) for honing and polishing. Also included are a trueing set (No. 711115) for trueing the stones and a sharpening stone holder (No. 711101).
No. 711107



C SHARPENING SET FOR KNIVES OF LOW-ALLOY CARBON STEEL »BLUE AND WHITE PAPER STEEL«
For repairing nicks, this set contains a King 220 grit coarse shaping stone (No. 711010). The King 1000/6000 grit combination stone (No. 711006) rests securely on the non-skid mat

(No. 705364) and is used for both sharpening and honing. The set also contains a trueing grille for sharpening stones (No. 711297) and a Togeru sharpening device (No. 705377) which helps maintain the correct angle when sharpening knives.
No. 711111



Price advantage!
D COMBINATION STONE, WITH OIL AND DVD
For sharpening and maintenance of tools and knives.
Set includes: Cerax combination stone grit 1000/6000 (No. 711546); DVD - Das Schärffen japanischer Messer (No. 713806), **in German**; Sinensis camellia oil (No. 705280).
No. 711027



Price advantage!
E COMBINATION STONE, WITH DIAFOLD® SHARPENER AND OIL
This collection of high-quality products includes all the basic equipment for sharpening knives and tools. The included sharpening primer (**in German**) gives instructions on how to proceed.

Set includes:
Japanese combination stone King, 1000/6000 grit (No. 711007); Non-skid mat (No. 705364); DMT Diafold (No. 705374); Sinensis camellia oil (No. 705280); Sharpening Primer.
No. 711029



G DAS SCHÄRFEN JAPANISCHER MESSER
A Japanese master blacksmith with a legendary reputation in Japan shows you how to professionally sharpen kitchen knives on waterstones. He introduces different types of waterstones, shows the correct sharpening motions for sharpening single- and double-bevelled knives and provides information on knife care. Knives that are sharpened following this method not only make the work easier but are also a pleasure to use and allow you to treat your food with respect.
In German.
No. 713806



Price advantage!
F COMBINATION STONE, WITH STONE HOLDER
For sharpening and finishing.
King combination stone, grit 1000/6000 (No. 711005); stone holder (No. 711101).
No. 711050

SHARPENING ON WATER-COOLED SHARPENING MACHINES



Using water-cooled sharpening machines is especially material-friendly. The grinding wheel runs through a water bath so that the cutting edge of the sharpened tool stays cool and will not anneal. This way of sharpening also saves time. It allows quick but gentle removal of material for knives with small break-outs.

The most important advantages at a glance:

- Safe handling, no sparks
- Gentle material removal, no overheating of the cutting edge
- Efficient grinding thanks to quick and gentle material removal
- No overheating thanks to water bath, no abrasive dust

Another advantage:

Water-cooled grinders can be used to sharpen all your cutting tools!

The Tormek T-8 (No. 716034) with its knife jigs (No. 705203, 705214 and 705232) allows you to precisely restore the original state of your knife blades with an optimal cutting angle. It is an »all-rounder« for a wide range of tools.

The Shinko sharpening machine (No. 716020) allows free-hand sharpening of nearly any tool shape; the horizontal construction combined with fine waterstones is ideal for kitchen knives.

H TORMEK® T-8 ORIGINAL

Proven over many years and constantly perfected wet-working sharpening machines are the basis of the ingenious Tormek sharpening system. A range of jigs, which can be mounted on the universal support, makes the sharpening of any cutting tool easier. Robust construction with solid housing and sliding water container.

The offered grinding wheels assure short sharpening times under all conditions in combination with the greatest possible tool protection. The leather honing wheel removes burrs quickly and leaves a perfectly polished cutting edge.



Includes:

- Square Edge Jig (SE-77)
- Adjustable Trueing Tool (TT-50)
- Stone Grader (SP-650)
- Pro Angle Master (WM-200)
- Honing Compound (PA-70)
- Handbook (HB-10)
- Instruction video (DVD-1)
- Edge Marker (EM-15)
- Voucher for free participation in a one-day workshop of your choice or a discount of 100 € for a multi-day workshop.



I TORMEK® HONING WHEEL SJ-250, GRIT 4000
Extreme polishing performance with hard bond. Particularly recommended for chrome-vanadium steel but also for HSS blades and double-layered steel.
No. 705457

Sharpening wheel:

»Tormek Original« (SG-250) aluminium oxide Ø 250 x 50 mm, grit 220 and leather honing wheel Ø 215 x 30 mm. Stainless steel spindle with EzyLock-System for easier stone assembly.

Motor: 230 V, 200 W, 90 rpm, torque 14.7 Nm, silent running, maintenance free motor, designed for continuous operation, 25 000 hour life.

Housing: Solid zinc cast housing with integrated vertical and horizontal support. Improved water container with screw lift for easy positioning, overspill rim, drip-off plate, magnetic swarf collector and magnetic cleaning scraper.

No. 716034



J TORMEK® HAND TOOL KIT HTK-806

Price advantage

Short jig, axe jig, knife jig, small knife holder, long slender knives jig, scissors jig. Comes in practical plastic box with hard foam inlay.
No. 705223



K SHINKO® SHARPENING MACHINE, STONE INCLUDED

The Shinko sharpening system enables you to achieve professional sharpening results. Clogging rarely occurs with the open-pored Japanese waterstones. Water cooling and flat grinding produces long-lasting and strong edges. Since use no heat is generated, the blade can be held very close to its edge and guided very accurately. No sparks are produced, allowing the device to be safely operated in workshops and instructional settings. The surrounding foam ring is easily pressed down when sharpening long blades.

Sharpening wheel: Japanese waterstone, grit 1000, Ø 180 x Ø 70 mm, thickness 20 mm, steel mount, wheel nut, splashguard.

Motor: 230 V, 125 W, 50/60 Hz, 450 rpm, gear-driven.

Housing: Plastic, tool rest adjustable in height and angle. Water container with valve, drain tube.

Overall weight approx. 5.5 kg
No. 716020

Trueing Shinko sharpening stones



For trueing Shinko sharpening stones we recommend the DMT Diamond Whetstone, Coarse No. 705366.



SHINKO® SHARPENING MACHINE, SET WITH 3 STONES *Price advantage*
Machine including three waterstones (grits 280, 1000 and 6000).
No. 716024



For illustration purposes only. Product may vary.

SHARPENING WITH KNIFE SHARPENING SYSTEMS

KME Sharpening System

The KME sharpening system combines a robust construction with high functionality. The sharpening process is quite simple and you hardly need any previous knowledge or experience.

- Stepless sharpening angle adjustment allows for cutting angles of 17-28°
- A 180° rotating knife clamp ensures that both sides are evenly sharpened
- No right- or left-handed restrictions
- The system can be held by the pistol-shaped handle for mobile use or slotted into the base
- Robust components made of metal, plastic and cherry wood
- Rubberised knife clamps protect the blade from scratches
- Maximum blade length: 16 cm

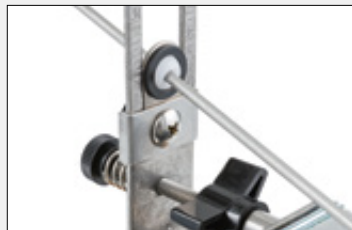

For illustration purposes only. Product may vary.

A KME SHARPENING SYSTEM, BASIC KIT

- Set includes:
- Diamond sharpening stones, grits: 140 (No. 720436) 300 (No. 720437) 600 (No. 720438) 1500 (No. 720439)
 - Cleaning cloth
 - Robust carrying case
- No. 720430**



B KME SHARPENING SYSTEM, DICTUM® KIT *Price advantage*

- Set includes:
- Accessory base (No. 720431)
 - Diamond sharpening stones, grits: 140 (No. 720436) 300 (No. 720437) 600 (No. 720438) 1500 (No. 720439)
 - Diamond lapping film set 9 micron (No. 720446) and 3 micron (No. 720444)
 - Stone thickness compensator (No. 720433)
 - Sinensis camellia oil (No. 705280)
 - Lubricating oil
 - Cleaning cloth
 - Robust carrying case
- No. 720448**

Grit comparison based on manufacturer's information on KME Diamond Lapping Film vs. grit specifications of JIS standard

KME micron	KME grit	JIS grit
9	1800	approx. 1500
6	3000	approx. 4000
3	6000	approx. 6000
1	16 000	approx. 7000
0.5	60 000	approx. 8000
0.1	160 000	approx. 9000

Grit comparison based on manufacturer's information on KME Diamond Stones vs. grit specifications of JIS standard

KME grit	JIS grit
100	approx. 50
140	approx. 100
300	approx. 200
600	approx. 500
1500	approx. 800

For accessories for the KME sharpening system see www.dictum.com

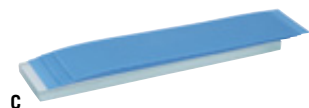

C KME DIAMOND LAPPING FILM SETS
Glass base for diamond lapping films, including 5 strips of self-adhesive abrasive with the respective grit. For polishing knife blades. With increasing fineness, the grain is to be classified as significantly coarser than according to the JIS standard.
Dimensions: 100 x 25 mm.

- Fits KME sharpening system No. 720448 and No. 720430.
- Grit
- 9 micron = grit 1800 **No. 720446**
 - 6 micron = grit 3000 **No. 720445**
 - 3 micron = grit 6000 **No. 720444**
 - 1 micron = grit 16 000 **No. 720443**
 - 0,5 micron = grit 60 000 **No. 720442**
 - 0,1 micron = grit 160 000 **No. 720441**



D KME DIAMOND SHARPENING STONES
Diamond sharpening stone suitable for the KME sharpening system. The grain is to be classified as significantly coarser than according to the JIS standard.
Dimensions: 100 x 25 mm.
Fits KME sharpening system No. 720448 and No. 720430.

Grit

- 100 **No. 720435**
- 140 **No. 720436**
- 300 **No. 720437**
- 600 **No. 720438**
- 1500 **No. 720439**



E KME LEATHER STROPS
This real-leather strop can be used untreated for homogenising metal or in combination with honing compounds for polishing the cutting edges.
Dimensions: 100 x 25 mm.
Fits KME sharpening system No. 720448 and No. 720430.
No. 720434

Edge Pro Sharpening System, Apex

With Edge Pro Apex you can easily create accurate bevels on knives. Even novices can achieve good results with this sharpening aid after a short training period. Entry level model with good price-performance ratio.

- Stepless sharpening angle adjustment allows cutting angles from 6-33°
- Sharpening stone replaced via clamping screw
- For very smooth surfaces (glass, ceramics), good stability is guaranteed; not suitable for wooden surfaces
- Components made of torsion-resistant plastic
- Adjustable tool stop for different blade widths
- Maximum blade length 19 cm



For illustration purposes only. Product may vary.



Blade stopper for 10-19 cm blade lengths included.

Grit comparison based on manufacturer's information on Edge Pro vs. grit specifications of JIS standard

Grit 220	approx. 140
Grit 400	approx. 800



For illustration purposes only. Product may vary.

F EDGE PRO SHARPENING SYSTEM, APEX 1 SET

With Apex 1 you get an inexpensive starter set with which you can achieve good grinding results on most knives. The set can be extended with the multi-purpose sharpening guide (scissor attachment) and is therefore ideal for ambitious hobby sharpeners.

Set contains:

- Sharpening stones, grit 220 (No. 708552) and 400 (No. 708553)
- Cleaning set
- Handy transport bag

Instructions in German, revised by DICTUM, and in English.

No. 708595

G EDGE PRO SHARPENING SYSTEM, APEX, DICTUM® SET

The set we have put together includes all the sharpening devices for sharpening kitchen and outdoor knives, closely following a standard sharpening procedure with a 1000/6000 combination waterstone. We recommend to watch the clear video tutorial (DVD included) for learning how to use the system quickly and easily. Since every sharpening stone needs to be trued from time to time to renew the structure or to ensure a clean edge, the DICTUM version also includes a trueing set. Due to its weight and smooth surface, the supplied granite stone plate can also be used as a base plate for the sharpening system to ensure optimum stability. The provided Sinensis camellia oil protects freshly sharpened blades from rust and, since it is food safe, is also perfect for kitchen knives.

Includes:

- Sharpening stones, grits 220 (No. 708552), 400 (No. 708553) and 1000 (No. 708555)
- Aluminium support for microabrasive (No. 708559)
- Microabrasive, self-adhesive, grit 2000 (No. 708547)
- Sharpening stone trueing set (No. 711115)
- Sinensis camellia oil (No. 705280)
- Cleaning set
- Handy transport bag
- DVD (in English) with instruction video

Instructions in German, revised by DICTUM, and in English.

No. 708596

Price advantage!



H



H EDGE PRO MAGNET FOR APEX, ADD-ON KIT

Magnetizing the blade table allows you to focus on creating a perfect edge instead of holding the knife steady. Where the magnetism will hinder your ability to sharpen, just deactivate the magnet. The add-on kit fits (tightly) under the table. For older models, you may have to replace the leg screws (included). Fits No. 708595 and 708596.

No. 708599



Edge Pro Sharpening System, Professional

Edge Pro Professional makes it incredibly easy to create a perfect knife edge. This sharpening device allows even novices to achieve optimal results after a short training period. The high-quality workmanship ensures a long service life and a pleasant sharpening experience.

- Continuously adjustable sharpening angle for cutting angles ranging from 6-33°
- No right-handed/left-handed restrictions thanks to the magnetic and partially magnetic blade securing mechanism
- Sharpening position ergonomically adjustable
- A tension spring mechanism makes it easy to change the sharpening stones
- Patented ramp system that enables sharpening up to the edge of the stone
- A vacuum suction cup ensures good stability on slippery surfaces
- Durable components made of metal and plastic
- Adjustable tool stopper for different blade widths
- Maximum blade length 19 cm

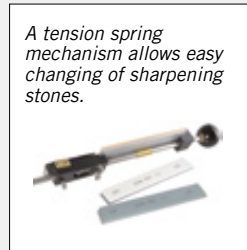

A tension spring mechanism allows easy changing of sharpening stones.



A

For illustration purposes only. Product may vary.



Blade stopper for 10-19 cm blade lengths included.



No right- or left-handed restrictions due to magnetic and partially magnetic blade fixing.

For illustration purposes only. Product may vary.

A EDGE PRO SHARPENING SYSTEM, PROFESSIONAL 1 SET

The Professional 1 provides you with a reasonably priced starter set that you can use to achieve good sharpening results on most knives. The set can be expanded with all accessories and is thus ideal for hobbyists.

Set contains:

- Sharpening stones, grits 220 (No. 708552), 400 (No. 708553)
- Cleaning set
- Robust carrying case
- DVD (in English) with video guide

Instructions in German, revised by DICTUM, and in English.

No. 708550



For a blade stopper for smaller knives see www.dictum.com

B EDGE PRO SHARPENING SYSTEM, PROFESSIONAL, DICTUM® SET

The set we have put together includes all the sharpening devices for sharpening kitchen and outdoor knives, closely following a standard sharpening procedure with a 1000/6000 combination waterstone. We recommend to watch the provided DVD with its clear video tutorial to learn how to use the system quickly and easily. Since every sharpening stone needs to be trued from time to time to renew the structure or to ensure a clean edge, the DICTUM version also includes an alignment set. The provided Sinensis camellia oil protects freshly sharpened blades from rust and, since it is food safe, is also perfect for kitchen knives.

Set contains:

- Sharpening stones, grit 220 (No. 708552), 400 (No. 708553) and 1000 (No. 708555)
- Aluminium base for microabrasive (No. 708559)
- Microabrasive, self-adhesive, grit 2000 (No. 708547)
- Sharpening stone trueing set (No. 711115)
- Sinensis camellia oil (No. 705280)
- Cleaning set
- Robust carrying case
- DVD (in English) with video guide

Instructions in German, revised by DICTUM, and in English.

No. 708558

Price advantage!

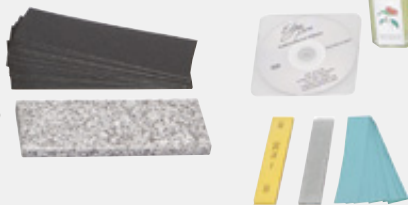

B

Benefits of the abrasive-guided knife sharpening systems

- Handling and use do not require any specific knowledge; even novices will achieve very good results
- The fixed support of the knife and the guided sharpening stone enable a precise sharpening angle, which is crucial to producing razor-sharp blades
- No scratches on the back of the blade thanks to the abrasive guide and the localized material removal, making it ideal for Damascus knives and etched blades
- The angled sharpening bench and smooth-running grinding arm enable the user to work ergonomically
- Synthetic waterstones ensure cold and gentle sharpening and therefore avoid heat generation on the cutting edges
- Adjustable sharpening angle to reshape bevels

- The hand-guided mechanism ensures a low operating risk

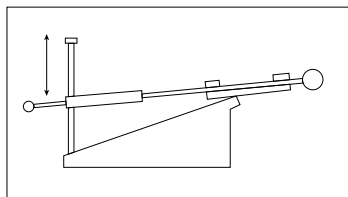

- Transportable; does not require a mains connection

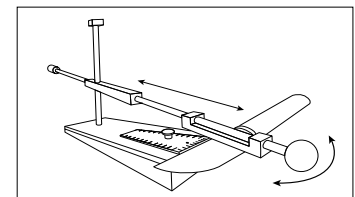



▶ Edge Pro Slide Guide for improved blade stabilisation and jigs for smaller knives available online.

www.dictum.com

Grit comparison based on manufacturer's information on Edge Pro vs. grit specifications of JIS standard

Grit fine	approx. 120	Grit 600	approx. 1200
Grit extra-fine	approx. 220	Grit 1000	approx. 2000
Grit 120	approx. 320	Grit 2000	approx. 6000
Grit 220	approx. 400	Grit 3000	approx. 8000
Grit 400	approx. 800	Grit 6000	approx. 10 000

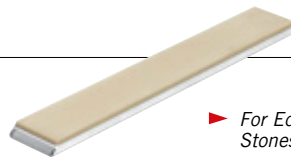

▶ For Edge Pro Matrix Diamond Sharpening Stones see www.dictum.com

www.dictum.com



C



D



E



F

C EDGE PRO SHARPENING STONES
Sharpening stone with aluminium holder, fits Edge Pro sharpening system No. 708550 and No. 708558. Made of aluminium oxide. The grit is to be rated much finer than sharpening stones classified according to JIS standard.
150 x 25 x 4 mm

Grit	
120	No. 708551
220	No. 708552
400	No. 708553
600	No. 708554
1000	No. 708555

D EDGE PRO MICROABRASIVES, SELF-ADHESIVE
Self-adhesive abrasive for polishing out scratches on knife blades. Fits glass base of the Edge Pro sharpening system (No. 708550 and 708558). Made of aluminium oxide. The grit is to be rated much finer than sharpening stones classified according to JIS standard.
15 pieces.
150 x 25 mm

Grit	
2000	No. 708547
3000	No. 708548
6000	No. 708549

E EDGE PRO DIAMOND SHARPENING STONES
Diamond sharpening stone on aluminium base. For ceramic cutting edges and the rough removal of material in the event of chipped/broken blades. Fits Edge Pro sharpening system No. 708550 and No. 708558.
150 x 25 mm

Grit	
fine	No. 708556
extra-fine	No. 708557

F EDGE PRO ALUMINIUM BASE
Aluminium support for microabrasive (No. 708547, 708548 and 708549). Fits Edge Pro Sharpening System (No. 708550 and 708558).
150 x 25 mm
No. 708559

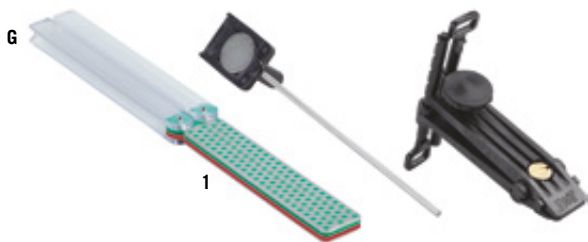

1

G DMT® DIAFOLD® MAGNA-GUIDE™ SHARPENING SYSTEMS
With the sharpening system from DMT, sharpening knives and tools becomes a breeze. The portable sharpening system has a blade clamp offering a 7-angle adjustability, which covers most blade geometries - from outdoor knives to fine cooking knives. A guide rod and magnetic attachment ensure the blade is always at the ideal sharpening angle. The deep clamp holds knives up to 9.5 mm thick without scratching the surface during sharpening.
Maximum blade length 12 cm



For illustration purposes only. Product may vary.

1 3-Piece Set
Set includes:
Clamp with adjustable guide, guide rod with magnetic attachment, diamond sharpener with folding handle (fine/extra-fine)
No. 705428



2

2 4-Piece Set
Set includes:
Clamp with adjustable guide, guide rod with magnetic attachment, diamond sharpener with folding handle (coarse/fine; extra-fine/extra extra-fine). Comes in practical plastic case.
No. 706296

Vide Application video available online.
www.dictum.com

Magna-Tec® Sharpening System Scorpio

The Scorpio knife sharpening guide from Magna-Tec combines robust construction with high functionality. It enables even sharpening beginners and inexperienced users to achieve impressive results.

- Continuously adjustable sharpening angle allows cutting angles of 9-36°
- No right- or left-hand restrictions due to magnetic blade fixing
- 4-in-1 blade support module for different knife blade lengths from 3 to 25.5 cm
- The system can be used both moving (pistol-type handle) and stationary (base)
- Easy change of sharpening stones due to tension spring mechanism
- Robust components made of metal and high-performance plastic
- Maximum blade length 25.5 cm
- Made in Germany



A tension spring mechanism allows easy changing of sharpening stones.

For illustration purposes only. Product may vary.



Rotatable tool stop for optimum guidance with all blade shapes and lengths.



No right- or left-handed restrictions due to magnetic blade fixing.

4-in-1 blade support module for different knife blade lengths from 3 to 25.5 cm

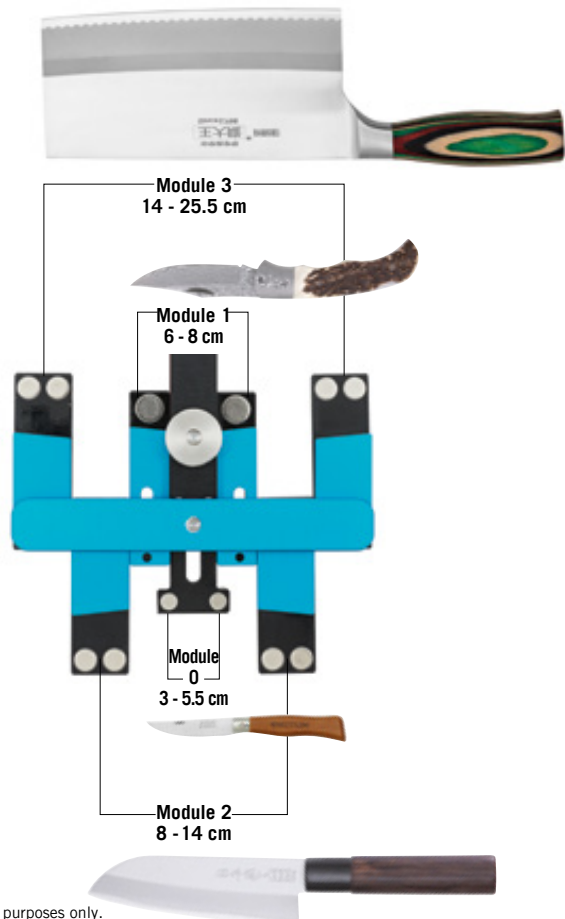

For illustration purposes only. Product may vary.

Vide on sharpening with knife sharpening systems available online.
www.dictum.com



A MAGNA-TEC® SCORPIO SHARPENING SYSTEM »BASIC«

- Set contains:
- Magna-Tec Scorpio (5-piece set)
 - 1 abrasive each incl. base: aluminium oxide, grit 320 (No. 728907) / grit 700 (No. 728908) / grit 1000 (No. 728909) / grit 2000 (No. 728910) / grit 3000 (No. 728911)

- 1 abrasive each: aluminium oxide, grit 320, 700, 1000, 2000 and 3000
 - Sturdy transport case
 - DVD with German video manual
 - Various small accessories
- No. 728904**

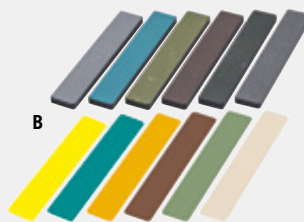

B MMAGNA-TEC® SCORPIO SHARPENING SYSTEM »PRO«

- Set contains:
- Magna-Tec Scorpio (5-piece set)
 - 1 abrasive each incl. base: diamond, grit 320 (No. 728927), grit 700 (No. 728928), grit 1000 (No. 728929), grit 2000 (No. 728930), grit 3000 (No. 728931) and grit 4000 (No. 728932)
 - 1 abrasive each: diamond, grit 320, 700, 1000, 2000, 3000 and 4000
 - Sturdy transport case
 - DVD with German video manual
 - Various small accessories

No. 728905



C MAGNA-TEC® SCORPIO SHARPENING SYSTEM »PRO PLUS«

Scope of delivery see Sharpening System »Pro« No. 728905

- + Abrasive incl. base, diamond (No. 728933), grit 6000
- + Abrasive, diamond, grit 6000
- + Diamond sharpening stone (No. 728950), grit 220

No. 728906



D MAGNA-TEC® SCORPIO ABRASIVES INCL. BASE, ALUMINIUM OXIDE
 Ready-to-use sharpening device consisting of base and attached self-adhesive abrasive, suitable for the Magna-Tec Scorpio sharpening system (No. 728904). Aluminium oxide abrasive, ideal for knives with a hardness under 60 HRC.
 100 x 19 x 5 mm.
 Grit
 320 **No. 728907**
 700 **No. 728908**
 1000 **No. 728909**
 2000 **No. 728910**
 3000 **No. 728911**
 4000 **No. 728912**
 6000 **No. 728913**
 8000 **No. 728914**
 10 000 **No. 728915**
 12 000 **No. 728916**



E MAGNA-TEC® SCORPIO ABRASIVES INCL. BASE, DIAMOND
 Ready-to-use sharpening device consisting of base and attached self-adhesive abrasive, suitable for the Magna-Tec Scorpio sharpening system (No. 728904). Diamond abrasive, ideal for knives with a hardness over 60 HRC.
 100 x 19 x 5 mm.
 Grit
 320 **No. 728927**
 700 **No. 728928**
 1000 **No. 728929**
 2000 **No. 728930**
 3000 **No. 728931**
 4000 **No. 728932**
 6000 **No. 728933**
 8000 **No. 728934**
 10 000 **No. 728935**
 12 000 **No. 728936**



F MAGNA-TEC® SCORPIO DIAMOND SHARPENING STONES
 High-quality diamond sharpening stone, fits Magna-Tec Scorpio sharpening systems (No. 728904). The diamond coating is ideal for ceramic knives and coarse material removal.
 100 x 19 x 6 mm.
 Grit
 60 **No. 728947**
 120 **No. 728948**
 180 **No. 728949**
 220 **No. 728950**

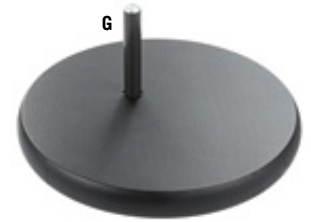

G MAGNA-TEC® SCORPIO BASE
 The Magna-Tec Scorpio sharpening system can be optionally attached to this base and within a few seconds for stationary sharpening, allowing you to work with one hand. Non-slip due to rubber studs. The rotating bearing allows for ergonomically ideal sharpening and a good view of the knife. Fits Magna-Tec Scorpio sharpening systems No. 728904, No. 728905 and No. 728906.
No. 728953

 For Magna-Tec® Scorpio aluminium oxide and diamond replacement abrasives see www.dictum.com

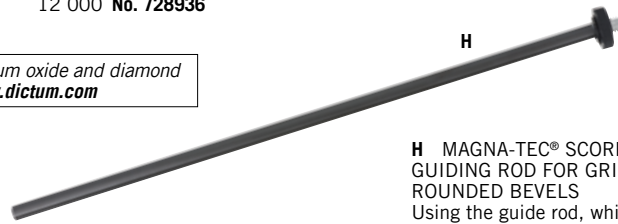

H MAGNA-TEC® SCORPIO GUIDING ROD FOR GRINDING ROUNDED BEVELS
 Using the guide rod, which is slightly curved at the thread, the Magna-Tec

Scorpio sharpening system allows you to also sharpen rounded bevels of 3.5°. This type of bevel is particularly popular with hunting or outdoor knives and ensures a more sturdy cutting edge. Fits Magna-Tec Scorpio sharpening systems No. 728904, No. 728905 and No. 728906.
No. 728952

HOW TO REPRODUCE A BEVEL WITH MAGNA-TEC® SCORPIO AND DELTA-S: A DIRECT COMPARISON

Example using a Victorinox vegetable knife:



Magna-Tec® Scorpio

1. Measure and note the blade length
2. Note the module in use
3. Insert the blade and transfer the resting point (measured from the knife tip to the right end of the module stopper, see arrow) onto the blade. Note the distance from the marking point to the tip of the blade
4. Note the (relative) sharpening angle indicated by the scale on the shaft

Knife	Blade length	Module	Rest point blade	(Relative) sharpening angle
Vegetable knife	100 mm	2	93 mm	20.25°

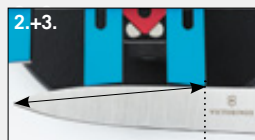

Magna-Tec® Delta-S

1. Measure and note the blade length
2. Note the module in use
3. Insert the blade and transfer the scale centre (0) to the blade; note the distance from the marking point to the tip of the blade
4. Use the scale to document the position of the tool stopper and the side of the blade stopper currently in use (narrow or broad)
5. Note the sharpening angle identified on the digital display (relative)

Knife	Blade length	Module	Rest point blade	Position of the tool stopper/orientation	(Relative) sharpening angle
Vegetable knife	100 mm	1	50 mm	5 mm / broad	22.2°

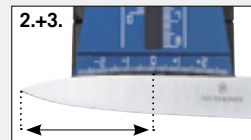

Magna-Tec® Sharpening System Delta-S

The Delta-S sharpening system from Magna-Tec combines the proven and traditional principle of sharpening by hand with the advantageous precision of a machine. It is possible to achieve impressive results that are not possible with a conventional knife sharpening device or sharpening by hand after only a short training period. The Delta-S stands out due to its high operating comfort, unique standard of quality and maximum sharpening results.

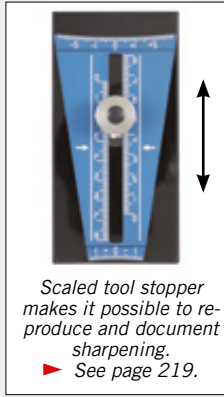

Scaled tool stopper makes it possible to reproduce and document sharpening. See page 219.



No right-handed/left-handed restrictions thanks to the magnetic and partially magnetic blade securing.



Magnetic system to change the sharpening stones quickly.

For illustration purposes only. Product may vary.



A MAGNA-TEC® DELTA-S SHARPENING SYSTEM

- Ball screw drive for fast, smooth and precise sharpening angle adjustment; stepless adjustment via an electronic protractor; possible cutting angles of 9-35°
- Positionable feet and solid weight of 3 kg make it very stable and resistant to slipping on all flat surfaces
- Dampened depth stop brakes the grinding arm gently, preventing risk of injury and damage to the knives
- Maximum blade length 32 cm
- Metal design milled from a single piece of material
- All individual pieces can be replaced



Swivel stopper provides optimal support for all blade shapes and lengths.

Includes:

- Inclinometer with digital display
- Four different blade rest modules
- Sharpening stones, one of each grit 220 (No. 708564) / 400 (No. 708565) / 1000 (No. 708566) / 2000 (No. 708567) / 3000 (No. 708568) / 5000 (No. 708569) / 10 000 (No. 708570)
- Strops, chromium oxide (No. 708584) / zirconium oxide (No. 708585) / untreated (No. 708586)
- Polishing pastes made of chromium oxide (No. 708582) / zirconium oxide (No. 708583)
- Adjustment and verification set
- Sharpening stone truing set
- Cleaning set
- Robust carrying case
- DVD with German video guide

No. 708560



Kit includes magnetic blade rest modules in four different sizes.



B MAGNA-TEC® DELTA-S REPLACEMENT STONES
Original Naniwa Specialty Stone, fits Magna-Tec Delta-S sharpening system (No. 708560). 125 x 22 x 10 mm.

- | | |
|--------|------------|
| Grit | |
| 220 | No. 708564 |
| 400 | No. 708565 |
| 1000 | No. 708566 |
| 2000 | No. 708567 |
| 3000 | No. 708568 |
| 5000 | No. 708569 |
| 10 000 | No. 708570 |

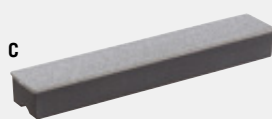

C MAGNA-TEC® DELTA-S DIAMOND STONES
High-quality diamond sharpening stone, fits Magna-Tec Delta-S sharpening system (No. 708560). The diamond coating is ideal for ceramic knives and rough removal of material. 125 x 22 mm.

- | | |
|------|------------|
| Grit | |
| 60 | No. 708561 |
| 120 | No. 708562 |
| 180 | No. 708563 |

D MAGNA-TEC® DELTA-S STROPS
Strop made of genuine leather for polishing knife blades. Suitable for the Magna-Tec Delta-S sharpening system (No. 708560). 125 x 22 mm.

Chromium Oxide
Treated with chromium oxide for fine polishing.
No. 708584

Zirconium Oxide
Treated with zirconium oxide for very fine polishing.
No. 708585

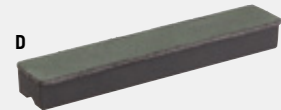

Untreated
Untreated for finalising. No removal of material - metal is homogenised.
No. 708586

For Magna-Tec® Accessories see www.dictum.com



POLISHING KNIFE BLADES

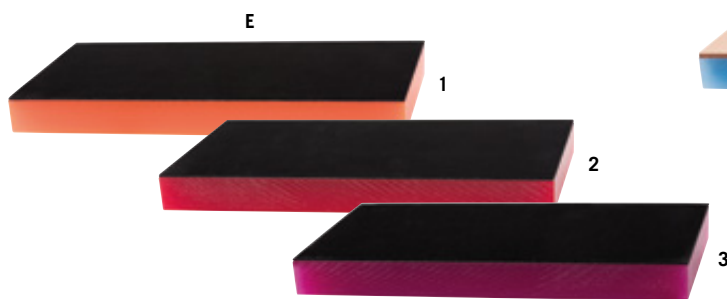

E JENDE NANOCLOTH ACRYLIC STROP BLOCKS

This strop block is ideal for polishing (stropping) cutting edges of knives and razors, as well as chisels or plane blades. The synthetically produced surface has no wave, and so the tools can be honed in all directions. Thanks to the different colour coding and grit specifications that are laser etched on the underside of the acrylic strop block, the polishing emulsion that is to be used on the surface can be immediately identified. The colour of the label on the bottle of the different polishing emulsions corresponds with the colour of the related strop block. Comes without poly emulsion.

210 x 70 x 20 mm

Grit indication	Base
1 0.025 Micron No. 729594	orange
0.10 Micron No. 729593	yellow
0.25 Micron No. 729592	green
2 0.5 Micron No. 729591	red
1 Micron No. 729590	blue
2 Micron No. 729589	purple
3 4 Micron No. 729588	pink

G JENDE POLY DIAMOND EMULSIONS

Polishing emulsion with diamond particles for polishing or stropping knives and razors, as well as chisels or plane blades. Fits Jende Nanocloth acrylic strop block or leather honing strop block. To apply the emulsion, we recommend removing the pump cover, tipping the emulsion onto the strop block and spreading it evenly with a finger.



1 25 ml Grit indication 0.025 Micron No. 729587	orange	2 50 ml Grit indication 0.025 Micron No. 729580	orange
0.10 Micron No. 729586	yellow	0.10 Micron No. 729579	yellow
0.25 Micron No. 729585	green	0.25 Micron No. 729578	green
0.5 Micron No. 729584	red	0.5 Micron No. 729577	red
1 Micron No. 729583	blue	1 Micron No. 729576	blue
2 Micron No. 729582	purple	2 Micron No. 729575	purple
4 Micron No. 729581	pink	4 Micron No. 729574	pink

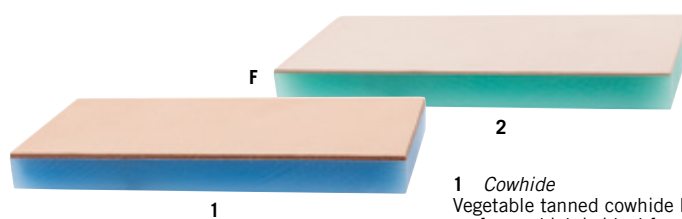

F JENDE LEATHER HONING STROP BLOCKS

Leather honing strop block for honing tool, knife and razor blades. After honing on benchstones, we recommend stropping on leather for ultra-sharp edges. Can be used with or without sharpening paste. 210 x 70 x 20 mm

1 *Cowhide*
Vegetable tanned cowhide has a harder surface, which is ideal for sharpening tool and knife cutting edges.
No. 729595

2 *Kangaroo Leather*
Vegetable-tanned kangaroo leather is softer and therefore more flexible, which is ideal for sharpening razor cutting edges.
No. 729596

What are the benefits of polishing cutting edges?

Prevention of rust:

In principle, the smoother a metal surface is, the less susceptible it is to rust. Polishing considerably reduces scratches on cutting edges. It is therefore quite useful, especially with blades made of classic, non-rustproof carbon steel (i.e. many Japanese kitchen and outdoor knives).

the material to be cut. For kitchen knives and woodworking tools, polishing increases the mechanical strength. For sailing knives (e.g. for cutting ropes) an unpolished blade is more stable. When cutting ropes or cables, a polished blade slips off more easily, and the cutting process therefore requires more pressure.

Increasing the mechanical resilience:

The micro-relief structure on the cutting edge is reduced by polishing. The cutting edge is more compact and less prone to breaking out. However, this also depends on the tool type and

Improving the sharpness:

If more points meet at the cutting edge, the blade is sharper. However, if the polishing time is too long or the polishing agents are too soft, the cutting edge will be rounded off.

1000x magnification of a knife blade with a cutting layer of VG-10 steel:

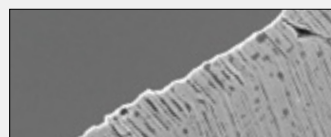

1000/6000 grit and polished on leather without paste.

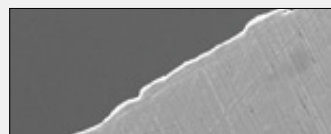

1000/6000 grit and polished with Jende Nanocloth Acrylic Strop Block and Jende Poly Diamond Emulsion, 4 Micron.

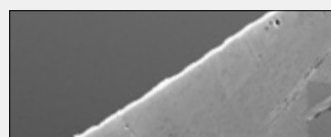

1000/6000 grit and polished with Jende Nanocloth Acrylic Strop Block and Jende Poly Diamond Emulsion, 4 and 0.5 Micron.

Workshops on Knife Making and Sharpening

CLASSIC

KNIFE MAKING

A knife after your fancy



Contents: Create your very own, individual knife. A wide range of high-quality Japanese multi-layered steel blades with 3 to 32 layers will be provided. You will design the handle and the guard and learn to fit

the blade into the handle, to grind and to sharpen the blade.

Qualification: None.
Participants: approx. 10 participants
Duration: 2 days

CLASSIC

DAMASCUS BLADE FROM JAPANESE STEEL

Damascus steel is not only good to sharpen, durable, sturdy, and resistant, it has a typical, vivid pattern that makes every knife unique.

Contents: We will forge a Damascus blade from White Paper Steel. Apart from forging the Damascus bar, grinding, hardening, and annealing the blade will also be taught in this course. In the end we will make a handle from precious wood and fit it onto the knife.

Qualification: None.
Participants: approx. 10 participants
Duration: 2 days

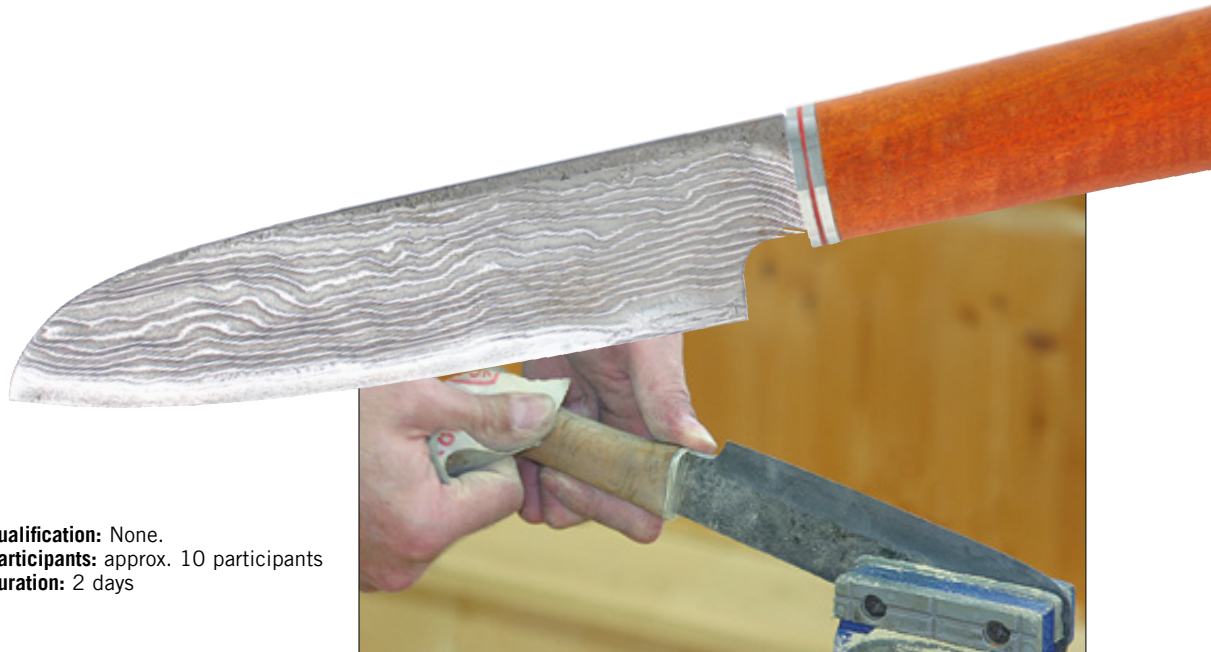

SHARPENING HIGH CLASS KNIVES

CLASSIC

We recommend sharpening high quality cutting steels by hand with waterstones, as this method has several advantages: It results in ultimate sharpness, is gentle to the steel, you can do it anywhere, quickly, and at a low cost.

blade. You will acquire extensive background knowledge on steel and sharpness. Demanding exercises under professional guidance will help you achieve perfect results.

► *Please bring your own knives!*

Contents: You will learn how to perfectly sharpen your knives on waterstones while preserving the

Qualification: None.
Participants: approx. 10 participants
Duration: 1 day



► **For all workshop dates see www.dictum.com/workshops or our online Workshop Scheduler!**

Workshops on Cooking and Kitchen

DRESSING AND SHARPENING

Not just for hunters

CLASSIC

Contents: This course begins with an introduction to the precise and gentle sharpening of high-quality knives (approx. 3 hours). Then you will learn to trim and gut game under the professional guidance of our experienced chef and hunter. The day ends with eating a jointly prepared venison meal together and a social gathering (finishes at approx. 6 pm).

Qualification: None.
Participants: approx. 10 participants
Duration: 1 day



DISCOVER OUR DICTUM BLOG TOOL KNOWLEDGE!

Interesting facts about woodworking and sharpening, tool knowledge, tips & tricks, tutorials and videos, as well as product presentations and news.

www.dictum.com/blog

BLOG:

SHARPENING TOOLS:
Five ways to sharpen knives



There is no one-size-fits-all method for sharpening knives. It is the result that counts. The knife must be sharp afterwards. Let us introduce you to five knife sharpening methods. For the full post see www.dictum.com/blog

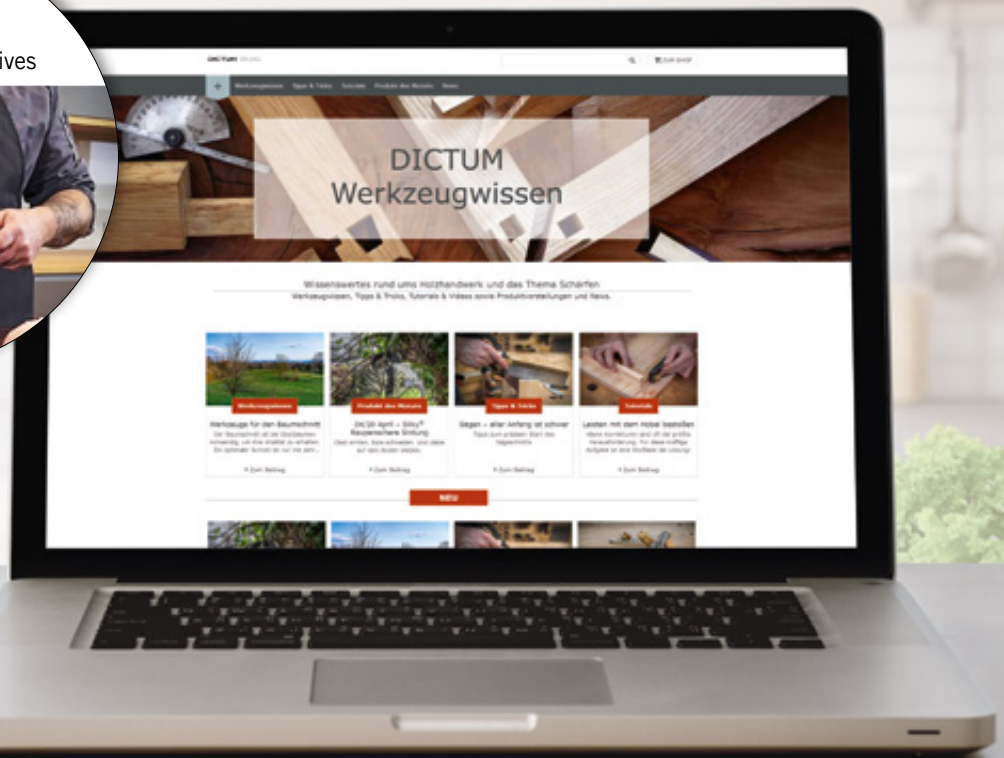

DON'T MISS OUT - FOLLOW US:



online
FLIP
Catalogue

Check out our Workshop Scheduler at
www.dictum.com/catalogues

Live and experience handicrafts - true to this motto we offer more than 300 workshops with firstclass instructors - all masters of their art. You work in a pleasant atmosphere, in small groups and with best tools.



Scan & open
online flip catalogue

Our Books

The deeper you explore a specific subject, the more fascinating it becomes. Books, DVDs as well as workshops offer an indispensable guide along your path of learning and discovering new insights. Our range of books mainly deals with tools, techniques and traditions of working wood by hand, metal work and gardening. The selection process is simple - all books we propose have been previously read and selected by our own experts for the quality of their content.



For more books on each subject see www.dictum.com



DAS GROSSE BUCH VOM MESSER

Oliver Lang-Geffroy:

The knife is the most important tool in the history of mankind, and at the same time a cultural legacy that is indispensable in our modern world. For many daily tasks, it is a helpful companion, and in emergency situations it can also save lives. Persons who are interested in knives will discover an exciting microcosm. There are countless knife types, steel grades, and production methods. But in what way do all these knives differ? What are the proper names of the various components? What properties does high-performance knife steel need to exhibit? Which blade shape and which type of edge is suited to what task? How do the various locking mechanisms for folding knives work? What is the right way to sharpen a knife? Well-founded answers to these and many other questions can be found in this comprehensively illustrated book.

213 pages, hardcover, numerous colour photographs, 265 x 205 mm. **In German.**

No. 714345

DAMASZENER - ZAUBER DER WILDEN KLINGEN

Heribert Saal:

The large-format book »Damaszener - Zauber der wilden Klingen« (Damascus Knives - Wild Blades that Fascinate) showcases numerous magnificent knives in large format. These knives are not only shown in their finished state, but also during the stages of manufacturing: from planning to the selection and forging of the steel — from the shape of the knife, to finding wood with the right grain. It provides suggestions and instructions which aid readers with finding their own perfect and aesthetically balanced knives, for their specific purposes.

144 pages, hardcover, approx. 200 colour photographs, 285 x 245 mm. **In German.**

No. 714347



MESSER - HANDWERK UND KULTUR DES KÜCHENMESSERS

Tim Hayward:

Interacting with knifemsmiths, chefs, and collectors, the food journalist Tim Hayward explores the world of knives: their design, production, and significance in the various cuisines and cultures of the world. Hayward presents over forty different knife types in detail - from German stainless steel blades, via the Chinese Chai Dao, to the Japanese Santoku made of Damascus steel. These portraits are complemented with practical tips for knife care as well as holding, cutting, and grinding techniques.

224 pages, hardcover, approx. 120 colour photographs, 160 x 240 mm. **In German.**

No. 714344

MESSERBAUEN FÜR EINSTEIGER

Lars Ohm:

The easy way to get into knife making as a hobby. This book will show you how you can attach a purchased blade to a handle you made yourself. An overview of the topic of knives, their design and the type of bevel used for different applications will make selecting the blade much easier. The book even includes a section on making appropriate leather sheaths with three different techniques. In short, it has everything that you need to build your own knife without special tools and without prior knowledge.

64 pages, paperback, colour illustrations and drawings on every page, 135 x 195 mm. **In German.**

No. 713041



MESSERKLINGEN UND STAHL

Roman Landes:

Technological observations on knife blades. With this in-depth technical book on metallurgy and factors affecting sharpness and durability, Roman Landes sheds light on the mysteries of blade alchemy. As well as types of steel, heat treatment and blade geometry, objective test methods and optimisation processes are discussed. A must for any ambitious knife maker and collector.

176 pages, hardcover, numerous diagrams and illustrations, 160 x 230 mm. **In German.**

No. 713166



MESSERMACHEN FÜR ANFÄNGER

Stefan Steigerwald and Dirk Burmester:

This volume on workshop practice shows step by step how to make a full- and stick-tang fixed-blade knife. After a brief introduction to steel, it presents the most common handle materials and the required tools. Then the individual work steps for making a knife are explained in detail. Starting with a sketch on paper, it guides you through sharpening the blade, assembly and final polishing of the handle to the finished knife. Every step is clearly described in words and pictures.

125 pages, spiral binding, numerous colour photographs, 175 x 230 mm. **In German.**

No. 713055



MESSER MACHEN WIE DIE PROFIS

Ernst G. Siebeneicher-Hellwig:

This book teaches you how to make your own knife. It starts with a brief introduction to steel and describes the most common handle materials and the required tools. For beginners, the book explains in detail the individual steps involved in making a knife, based on various kits (including hunting knives and folding knives). For advanced knife makers, it contains instructions for developing and making your own knives from scratch. Information on embellishment and decorating techniques complete the book.

128 pages, hardcover, approx. 100 colour photographs, 163 x 219 mm.

In German.

No. 713004



MESSER SCHÄRFEN WIE DIE PROFIS
Carsten Bothe:
Knives need regular care and must be sharpened correctly. This book introduces suitable sharpening tools and explains the correct sharpening technique for each tool. It also explains the correct way to sharpen axes, scissors and tools. Numerous tips by the author make sharpening a pleasure.

112 pages, paperback, about 60 colour photographs, 158 x 213 mm. **In German.**
No. 713167



JAPANMESSER SCHÄRFEN
Rudolf Dick:
Everything you ever wanted to know about sharpening Japanese knives: Step by step, with numerous illustrations, expert Dr. Rudolf Dick explains an exact and practical sharpening technique. This book also helps you select the correct sharpening stones and details the special characteristics of Japanese knives. Important practical tips for care and correct application complete this comprehensive work.

125 pages, hardcover, colour photographs on every page, 165 x 235 mm. **In German.**
No. 713920



MESSERSCHARFE KUNST - MIT DEM AMBOSS PER DU
Heribert Saal:
This book allows you to look over the shoulder of the blacksmith Kilian Kreuzt. It plunges you in the ancient craft of forging, using a hammer, anvil, fire, and glowing coals.
148 pages, hardcover, approx. 120 colour photographs, 235 x 155 mm. **In German.**
No. 714346



TAKE A LOOK INSIDE!
at www.dictum.com/books

SERVICES

Hardness test

We test the hardness (HRC) of your knife blade at its cutting edge using the Vickers testing method, which involves very low test pressures and allows us to test the cutting edge without damaging it. You will receive a test certificate with impression images and the Vickers values converted to HRC.

Fee for the hardness test plus test certificate **€15.00**

For further information on our hardness test see www.dictum.com/service

Hardening service

We offer customers a qualified blade hardening service (up to 100 cm). The service includes a free original test certificate with the exact hardness value of the cutting edge in HRC (Rockwell). This will provide you a clear understanding of the actual end hardness of your blade after hardening.

Fee for the hardening service plus test certificate **€29.90**

For further information on our hardening service see www.dictum.com/service

DELIVERY COSTS (PRIVATE CLIENTS)

Delivery within Germany

Delivery free of charge for orders over €150.00 (including 19 % VAT).

For orders below this amount a €4.95 (€4.16 + 19 % VAT) shipping charge including P&P will be added.

Express delivery:

Express deliveries on the next working day are guaranteed only for orders placed until 2 pm by phone. For express deliveries we will charge additional shipping costs of €13.00 (€10.92 + 19 % VAT).

Delivery to other countries

Please find information on delivery costs to other countries at www.dictum.com/delivery-costs

General sharpening service

Our sharpening experts - who are trained in Japan - are happy to sharpen your blades at discount prices.

Knives (full flat grind of hunting and carving knives only on request) **€7.00**

Axes, plane blades, woodturning tools, carving and sculpting tools, scissors **€9.00**

Chisels (only bevel and honing the back) **€6.00**

Chisels (bevel and back) **€13.00**

*Inclusive additional **trueing** and **polishing** of the back**

Plane blades (bevel and »Ruler trick«** on the back of the blade) **€6.00**

Plane blades (bevel and back) **€13.00**

*Inclusive additional **trueing** and **polishing** of the back**

Garden and hedge shears **€12.00**

Hair cutting scissors (only products from our range) and razors **€19.00**

For extremely time-consuming sharpening processes that require additional effort, we reserve the right add a surcharge of € 7.00. In this case, our sharpening expert will get in touch with you before starting the work.

If products are sharpened prior to dispatch on the customer's instructions (special order), these are excluded from the right of return and exchange.

** When sharpening Japanese blades, the hollow grinding may be reduced depending on the original flatness of the back.*

Plus shipping charges (prices include VAT).

**»Ruler trick« - The Lie-Nielsen Method

A thin steel ruler is placed along the long edge of a fine-grit honing stone and the very tip of the back of the blade polished along the opposite long edge of the stone. See expert knowledge »Sharpening Plane Blades« at www.dictum.com

Sharpening advice: +49 (0)9931 4058-971

If you wish to use our Sharpening Service, please send the blades to be sharpened along with the properly completed Sharpening Order Form (available at www.dictum.com/schaerfauftrag) to DICTUM GmbH • Sharpening Service • Gottlieb-Daimler-Str. 3 • 94447 Plattling • Germany. We will return your sharpened cutting tool within a few days. You only have to pay the shipping costs.

TIP: Products with this symbol can be sharpened by our experts free of charge. For further information about our free sharpening service, see page 4.



Our Obligation to Inform

The contractual partner is DICTUM GmbH, Gottlieb-Daimler-Str. 3, 94447 Plattling, Germany
Telephone: +49 (0)9931 4058-902, Fax: +49 (0)9931 4058-800; E-mail: info@dictum.com
If you have any complaints or questions regarding the contract, please contact the above address.

1) Prices

- 1.1 Unless otherwise stated in the Seller's product descriptions, the prices indicated are total prices and include the statutory Value Added Tax (VAT). The Seller reserves the right to adjust the prices if the VAT rate is altered. Any potential additional delivery and dispatch costs are not included in the price of the product(s) but are specified separately in the respective product description. Unless otherwise agreed, shipping costs must be borne by the Customer. For international orders, the Seller reserves the right to choose express delivery as the method of shipping if in this case the shipping costs are lower than that of standard shipping.
- 1.2 In the case of deliveries to countries outside the European Union, additional costs may be incurred in individual cases for which the Seller is not responsible and which have to be borne by the Customer. These include, for example, transfer fees charged by banking institutes (transfer charges, currency conversion fees) or import duties or taxes (customs). Such additional costs regarding money transfers may also be incurred if the Customer initiates the payment from a country outside the European Union, even if delivery is not made in a country outside the European Union.
- 1.3 The prices shown in the catalogue are valid until 31st July 2021. After 31st July 2021, the Seller reserves the right to make price adjustments due to short-term price changes introduced by suppliers, currency fluctuations or similar. Any order placed after 31st July 2021 that has not been placed through our online shop (www.dictum.com) will be accepted on the basis of the catalogue prices (order confirmation) provided that no price alterations have been necessary. In the case of necessary price alterations, the Seller shall submit a new price offer. If the latter is the case, the contract shall only be concluded if the Customer explicitly accepts this offer within 14 days.
- 1.4 Book prices are subject to national book price maintenance. In the case of a price increase on the part of the publisher, the Seller shall be obliged to charge the new price.

2) Terms of Payment for Catalogue Orders

Payment in advance (a 2 % discount shall be granted if payment is made in advance by means of bank transfer; this does not apply to vouchers), invoice (15 days net without discount), direct debit. Other payment methods are available for online orders (see www.dictum.com/de/zahlungsarten). The Seller reserves the right to restrict the payment method to advance payment.

3) Shipment and Delivery Conditions

- 3.1 Goods are generally delivered to the delivery address indicated by the Customer, unless agreed otherwise.
- 3.2 If goods are delivered by freight carrier, the goods shall be delivered free to kerbside, i.e. to the public kerbside which is closest to the delivery address, unless otherwise stipulated in the shipping information displayed in the Seller's online shop or unless otherwise agreed.
- 3.3 Should the assigned transport company return the goods to the Seller because delivery to the Customer was not possible, the Customer shall bear the costs for the unsuccessful dispatch. This shall not apply if the delivery cannot be made due to circumstances beyond the Customer's control or if the Customer has been temporarily impeded from receiving the offered service, unless the Seller has notified the Customer about the service a reasonable time in advance. Furthermore, this shall not apply if the Customer effectively exercises their right of revocation. In the event that the Customer has effectively exercised their right of revocation, the provision made in the Seller's revocation policy shall apply for the return costs.
- 3.4 In the case that the Customer is a consumer, the risk of accidental destruction and accidental deterioration of the sold goods shall be transferred to the Customer upon delivery of the goods to the freight forwarder, carrier or other person or institution designated with the task of performing shipment. This notwithstanding, it shall also apply to Customers who are consumers that the risk of accidental destruction and accidental deterioration of the sold goods shall be transferred to the Customer upon delivery of the goods to the freight forwarder, carrier or other person or institution designated with the task of performing shipment if the Customer has instructed the freight forwarder, carrier or other person or institution designated with the task of performing shipment to carry out the delivery of the goods and if the choice of this person or institution was not previously offered by the Seller.
- 3.5 The Seller reserves the right to withdraw from the contract in the event of incorrect or improper self-supply. This shall only apply if the Seller is not responsible for the non-delivery and if the Seller has shown the required diligence and concluded a specific hedging transaction with the supplier. The Seller shall make all reasonable efforts to procure the goods. In the case of non-availability or partial availability of the goods, the Seller shall inform the Customer and grant the Customer immediate counterperformance.
- 3.6 Should the Customer collect the goods themselves, the Seller shall initially inform the Customer by e-mail that the goods are available for collection. After receiving the e-mail, the Customer may collect the goods from the Seller's site in consultation with the Seller. In this case, shipment costs shall not be charged.
- 3.7 Delivery to recipients in Germany shall be made within 1-3 working days, unless otherwise stated in the product description. For information on delivery times to other countries see www.dictum.com/service

4) Online Dispute Resolution

The EU Commission provides on its website the following link to an online dispute resolution (ODR) platform: <https://ec.europa.eu/consumers/odr>. This platform acts as a point of contact for out-of-court resolutions of disputes arising from online sales and service contracts concluded between consumers and traders. The Seller is neither obliged nor prepared to attend a dispute settlement procedure before an alternative consumer arbitration board.

5) Rectification of Defects

Should the object of purchase be deficient, statutory provisions shall apply. Deviating therefrom, the following shall apply:

- 5.1 If the Customer is a consumer, the following restriction shall apply to used goods: Claims for defects are excluded if the defect does not occur until one year after delivery of the goods. Claims for defects that occur within one year of delivery of the goods can be asserted within the statutory limitation period.
- 5.2 The aforementioned limitations of liability and the restrictions of limitation periods shall not apply
 - to products which have been used in accordance with their usual application for building construction and which have caused the building's defectiveness,
 - to claims for damages and reimbursement of expenses by the Customer, or
 - if the Seller has fraudulently concealed the defect.

6) Data Protection

For detailed information on data protection see www.dictum.com/en/privacy-and-data-protection

7) The Customer's Right of Revocation

Consumers shall be entitled to the right of revocation according to the following provisions, whereby the consumer is any natural person entering into a legal transaction for a purpose that can predominantly be attributed neither to a commercial nor a self-employed professional activity.

Instructions for Cancellation

A) Right of Revocation

The Customer shall be entitled to revoke the concluded contract within a period of one month without stating reasons. The revocation period of one month shall commence upon the day when either the Customer or a third party, who has been personally named by the Customer and who is not the carrier, has taken ownership of the goods. If the Customer has ordered several goods within one joint order and the goods are delivered separately, the revocation period of one month shall commence upon the day when either the Customer or a third party, who has been personally named by the Client and who is not the carrier, has taken ownership of the last delivered item. If the Customer has ordered an item which is delivered in several partial shipments or pieces, the revocation period of one month shall commence upon the day when either the Customer or a third party, who has been personally named by the Customer and who is not the carrier, has taken ownership of the last partial shipment or the last delivered piece. If the Customer has ordered goods which shall be delivered regularly over a specified period, the revocation period of one month shall commence upon the day when either the Customer or a third party, who has been personally named by the Customer and who is not the carrier, has taken ownership of the first delivered item. To exercise their right to cancel, the Customer must inform the Seller (DICTUM GmbH, Gottlieb-Daimler-Str. 3, 94447 Plattling, Germany; Tel.: +49 (0)9931 4058-902; Fax: +49 (0)9931 4058-800; E-mail: info@dictum.com) of their decision to cancel this contract by means of an unequivocal statement (e.g. a letter sent by post, fax or e-mail). The Customer may use the cancellation form template (B), but it is not obligatory. To meet the cancellation deadline, it is sufficient for the Customer to send their communication exercising their right to cancel before the cancellation period has expired.

Consequences of Revocation

If the Customer revokes the contract, the Customer shall be reimbursed all payments including the shipping costs (with the exception of the supplementary costs resulting from any mode of shipment chosen by the Customer other than the offered, least expensive mode of standard shipment) without undue delay and in any event not later than 14 days after receipt of the revocation notice. The reimbursement shall be effected using the same payment method as was used for the initial transaction, unless other terms have explicitly been stipulated; the Customer shall not incur any fees as a result of such reimbursement. The Seller may withhold reimbursement until the returned goods have been received or until the Customer has supplied evidence of having sent back the goods, whichever is the earliest. The Customer shall send back the goods or hand them over without undue delay and in any event not later than 14 days from the day when the Customer has communicated the revocation of the concluded contract. The deadline shall have been met if the Customer sends back the goods before the period of 14 days has expired. The Customer shall bear the direct cost of returning the goods. Notwithstanding the foregoing provision, the Seller shall bear the costs of returning goods which are consignable by parcel post if the Customer uses the prepaid return shipping label enclosed to return the goods. If the goods cannot be shipped as a parcel, the returning costs shall be estimated corresponding to and not exceeding the initial shipping costs. If the goods cannot be shipped as a parcel, the Seller shall organise the collection of the goods from the Customer's premises if requested by the Customer. If the Customer exercises this option, the returning costs borne by the Customer shall correspond to the initially quoted shipping costs. The Customer shall only be liable for any diminished value of the goods resulting from any handling other than that which is necessary to establish the nature, characteristics and functioning of the goods.

B) Cancellation Form Template

If you wish to cancel this contract, please complete and submit this form to:

DICTUM GmbH
Gottlieb-Daimler-Str. 3
94447 Plattling
Germany
Fax: +49 (0)9931 4058 800
E-mail: info@dictum.com

I/We (*) hereby give notice that I/We (*) cancel my/our (*) contract of sale for the following goods (*)/for the supply of the following service (*),

Ordered on (*) _____ received on (*) _____

Name of consumer(s) _____

Address of consumer(s) _____

Signature of consumer(s) (only if this form is submitted on paper) _____

Date _____

(*) Delete as appropriate

8) Exclusion of the Right of Revocation

The right of revocation does not apply to consumers who do not belong to a member state of the European Union at the time of the conclusion of the contract and whose sole residence and delivery address are outside the European Union at the time of the conclusion of the contract. The right of revocation does not apply for distance contracts for

- the delivery of goods that are manufactured according to the Customer's specifications or that are clearly adapted to personal requirements, or due to their nature are not suitable for return shipment, or may deteriorate rapidly, or if after shipping their sell-by-date would be exceeded;
- the delivery of audio or video recordings or of software if the delivered data medium has been unsealed by the Customer;
- the delivery of newspapers, magazines and periodicals, unless the Customer has submitted the contractual statement by telephone;
- the provision of other services relating to leisure activities, where the contract provides for a specific date or period of time for the provision of such services.

9) Return and disposal

For detailed information on the return and disposal of electrical equipment in accordance with the WEEE Directive see <https://www.dictum.com/en/return-disposal>

Obligation to provide information according to Art. 18 (2) WEEE Directive:
<https://www.bmu.de/themen/wasser-abfall-boden/abfallwirtschaft/statistiken/elektro-und-elektronikaltgeraete/>

Our general terms and conditions apply. You can find them at www.dictum.com/en/general-terms-and-conditions

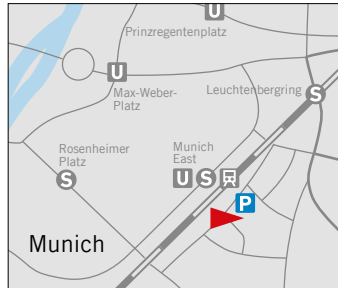
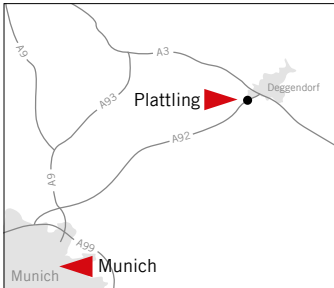

DICTUM Retail shops

- ▶ **Touch and try** for as long as you want
- ▶ **Stay a while and relax** in our reading corner with a cup of coffee or tea

DICTUM Shop Plattling

Gottlieb-Daimler-Str. 3
94447 Plattling
Germany

Telephone

+49 (0)9931 4058-410

P Free parking

DICTUM Shop Munich

Haager Str. 9, 2nd Floor
81671 Munich
Germany

Telephone

+49 (0)89 638908-91

P Free parking (adjoining multi-storey car park, top floor D; direct access to our shop)

DICTUM Workshops

www.dictum.com/workshops

Learn how to expertly handle tools, materials, and techniques in the stimulating environment of one of our workshop centres.

DICTUM Tool Knowledge Blog (in German)

www.dictum.com/blog

The DICTUM Tool Knowledge Blog provides you with access to one of our most important knowledge platforms. Our experts will guide you through all you need to know about woodworking and sharpening tasks.

DICTUM Handicraft Gallery (in German)

www.dictum-handwerksgalerie.de

Get inspired by the items produced by our customers and employees. Our handicraft gallery contains thrilling DIY objects and projects. We would love you to add your projects to those on display there!

DICTUM Online shop

www.dictum.com

In our online shop you will find:

- ▶ New products
- ▶ Interesting offers
- ▶ A wide range of products
- ▶ Lots of useful tips and tricks
- ▶ Helpful expert knowledge

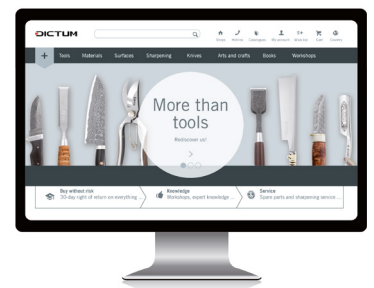

DICTUM Newsletter

Subscribe, keep up to date, benefit

www.dictum.com/newsletter

A newsletter you will really benefit from:

- ▶ Exciting new products
- ▶ Selected offers and promotions **for subscribers only**
- ▶ New video tutorials and blog posts
- ▶ Creative hands-on activities and raffles
- ▶ Tips and tricks on how to handle your tools correctly
- ▶ And much more

As a subscriber, you will also benefit from **limited price advantages on selected new products!** Benefit from exclusive offers – subscribe to our newsletter!

It is also important to us that we compile and distribute our newsletter with careful consideration. As ever, DICTUM is about quality, not quantity!

Always up to date: our social media channels!

Facebook - Instagram - YouTube

This is where handicraft lovers can meet like-minded people, comment, and exchange ideas. Our YouTube channel provides you with a variety of information videos and practical tutorials on a wide range of craft topics.



DICTUM.MehrAlsWerkzeug



dictum_mehr_als_werkzeug



DictumGmbH

www.dictum.com

Order Hotline:
Telephone: +49 (0)9931 4058-902
Fax: +49 (0)9931 4058-800
DICTUM GmbH • Gottlieb-Daimler-Str. 3 • 94447 Plattling • Germany
www.dictum.com • info@dictum.com

Version March 2021



Value €5.00